

ROSE

Health Care, L.L.C.

*Outstanding
Customer Service*

Quality Products

Fair Prices

*New Product
Edition*



*Be Active
Be Comfortable*

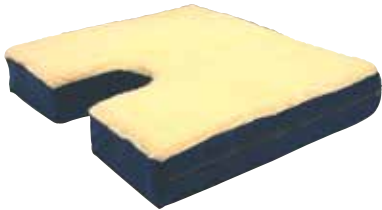

224 Rose Drive • Brunswick, Georgia 31520
Call Toll-Free (800) 457-7648 or Fax Toll Free (800) 536-2017
or Call (912) 466-0022 or Fax (912) 466-9884
rosecare@bellsouth.net • www.rose-healthcare.com

ROSE

Health Care, L.L.C.

224 Rose Drive
Brunswick, GA 31520

Call Toll-Free (800) 457-7648

(912) 466-0022

Fax Toll Free (800) 536-2017

(912) 466-9884

e-mail: rosecare@bellsouth.net



A Message From Rose Health Care...

Our purpose is to provide quality health care products at fair prices with outstanding customer service. This positive approach comes from the many years our management team has spent in the health care field. We appreciate the support from our loyal customers who have helped us become one of the fastest growing companies in the health care field.

Our product line of durable medical equipment and medical soft goods consist of direct imports and products we manufacture in our own facilities.

Our new catalog contains a vast array of new products. We welcome the opportunity to be of service to you and your company.



"THE WINNING TEAM"
Thanks for the opportunity to be of Service

Don Mann

Sandy Stossmeister

Meet The Rose Health Care Team

Don Mann (*President*) Co-Founded Duro-Med Industries and served as its president for almost 25 years. In 2001 he joined with several former employees of Duro-Med and formed Rose Health Care. His extensive experience in product development and marketing help make Rose Health Care an important factor in the market place.

Sandy Stossmeister (*Vice-President*) Served in various executive positions with Duro-Med and provides a strong background and expertise in operations, customer service and sales.

Dave Hirsh (*Director of Purchasing*) Formerly Vice-President in charge of Purchasing with Duro-Med brings over 30 years of experience in the health care field. He has traveled extensively in the Far East and has developed resources all over the world. This has enabled Rose Health Care to be extremely competitive.

Plus a loyal and devoted group of employees. That help make up **"The Winning Team"**.

Catalog is available online at:
www.rose-healthcare.com

What Our Customers Say About Us

"We can call and get a live person on the phone who is eager to help us in any way."

"If they don't have the product we are looking for, they will help us find the source."

"Rose Healthcare is always coming up with new and creative products."

"I always receive my products within a few days and that makes our customers happy."

HCPCS

*Providers are responsible for determining appropriate billing codes for Medicare Program claims This information is included for your convenience and is not intended, nor should it be considered billing advice.

Quality Products • Fair Prices • Outstanding Customer Service



HCPCS
E0143W

HCPCS
E0156

Four Wheeled Rollators

- Adjustable height handles with comfortable foam hand grips: adjusts 34" - 38"
- Loop-type cable hand brakes operate on rear wheels
- Padded seat lifts up to accommodate removable 6" x 6" x 13" wire basket with handle
- Smooth rolling 6" wheels
- Padded backrest for extra comfort
- Easy folding mechanism for transport and storage
- Lightweight Aluminum - 17 lbs. total - Weight Capacity 250 lbs.

#1010-BL Blue

#1010-BG Burgundy

Junior 4 Wheel Rollator

- Easy fold 13" x 13" seat
- Lightweight aluminum - 13 lbs.
- Removable padded back rest
- Adjustable height 29" - 34"
- Overall width 22"

#1003 Junior

4 Wheel Rollator
Burgundy or Blue

Three Wheel Rollators

- Anatomical grip with patented loop braking system
- 8" foam tires with wheel locks
- Foldable for easy storage and transport
- Includes deluxe carrying pouch
- Weight: Standard - 13 pounds
- Weight Capacity: 250 pounds
- Height adjusts 32"-36"



#1009

HCPCS
E0143

#1009 Three Wheeled Rolling
Walker-Burgundy

Seatbelts Included
at No Extra Charge

Light Weight Aluminum Transport Chairs - 19"

- Deluxe nylon upholstery
- Fold down handles for easy storage
- Padded armrests, swing away removable footrests
- Precision sealed wheel bearings
- 8" wheels with rear castor brakes
- Aluminum: 19 pounds without riggings
- Weight capacity: 250 pounds
- Warranty: Lifetime on side frames and cross braces

#1007BL Blue

#1007BG Burgundy

HCPCS
E1038



#1013

Wheelchair/Transport Chair Safety Seatbelt

- For use on most all wheelchairs and transport chairs
- 60" length, heavy-duty black nylon construction
- Automotive-style push button release buckle

#1013 Wheelchair/Transport Chair Safety Seatbelt

2-in-1 Rollator and Transport Chair

"Security & Convenience"

- Aluminum frame 8" wheels
- Loop brakes - locking wheels when seated
- Padded seat (13"x14")
- Adjustable handle height 34-1/2"-39"
- Weight - 15 lbs. - Capacity - 250 lbs.

#1012 BG Burgundy

#1012 BL Blue

HCPCS
E0143

HCPCS
E0156



NEW!



Rose Steerable Knee Walker

- No assembly required - adjustable height knee platform
- Frame made of steel for durability
- Weight limit of 300 lbs.
- Basket included for convenient storage
- Width: 16.6 in; Height: 42.2 in; Length: 31.41 in; Weight - 24 lbs.
- Wheel Size: 6.5" diameter

#1006B Knee Walker (Blue)

#1006R Knee Walker (Red)

#1006P Replaceable Knee Pads

HCPCS
E0118

NEW!

350 LB
WEIGHT CAPACITY



#1005D Deluxe Knee Walker

#1005DP Replacement Pads

Deluxe Knee Walker

HCPCS
E0118

- 4 large 8" rubber wheels with sealed bearings
- Adjustable hand brake, lockable "parking feature"
- Padded knee platform with easy folding mechanism
- Includes handy storage basket
- Padded foam handle-bar grips
- 120° turning radius
- Offset post on knee platform allows for right to left adjustment
- Powder coated black frame finish
- Two year warranty
- Knee Platform 7" w x 14" l
- Height adjusts 31"-41"

NEW!



Universal Fleece Knee Pad Cover

- Universal fit for all knee walkers
 - Easy-on stretch elastic for snug fit
- #1022 Fleece Knee Pad Cover

HCPCS
E0274



#2010

EASY
ASSEMBLY



#2012

Overbed Tables

- Available in both tilt and stationary tops
- 30" x 15" wood grain laminated top with raised plastic edge on tilt top prevents items from rolling off table top. Makes an excellent dining, reading or work surface
- Chrome plated H base for improved stability, swivel castor wheels allows for easy positioning
- Height adjusts 28" to 45" for use in bed or chair
- Easy assembly, shipped KD 1 per carton - 24 lbs.

#2010 Non-Tilt Overbed Table

#2012 Tilt Top Overbed Table

HCPCS
E1118



HCPCS
E0135

#1000

Single Button Folding Walker

- Lightweight 1" anodized aluminum frame
- Single release folding mechanism allows quick and easy fold down
- H-crossbar positioned high for over toilet use
- Height adjusts from 31" to 36"
- 2 per carton, weight - 16 lbs.

#1000 Deluxe Center Button Folding Walker

HCPCS
E155



#1004

Walker Wheels

- Provides easier rolling over different surfaces
- Attaches to front legs of walker only

#1004-3 Walker Wheels, 3" (pair)

#1004-5 Walker Wheels, 5" (pair)

Walker Ball Glides

NEW!



- Pre-cut, easily inserted into rear legs
- Perfect for smooth mobility
- Specify red or gray

#1047 Walker Ball Glides (pair)



HCPCS
E0143

NEW!
Lever
Release

#1002W

Dual Release Folding Walker

- Lightweight 1" anodized aluminum frame.
- Easy to use dual lever release allows walker sides to fold independently
- H-crossbar positioned high for over toilet use
- Height adjusts from 32" to 39"
- Overall width 22" Overall depth 19" width between grips 18"
- Weight capacity 300 lbs.

#1002 Dual Release Folding Walker #1002W - Dual Folding Walker with 5" Wheels, Standard

HCPCS
E0135

HCPCS
E0143



#3011

Fleece Walker Grip

- Soft synthetic sheepskin
- Adjusts with hook and loop closure
- Machine washable

#3011 Fleece Walker Grips (pair)

#3011LPD Leopard Walker Grips (pair)

NEW!

Ski Walker-Glides

NEW!



- Greater stability and ease of motion
- Simply slip on base of walker shaft
- Sturdy rubber and nylon
- 3-3/8" x 2" x 1-1/2" overall

#1021 Ski Walker-Glides (pair)



300 LB
WEIGHT CAPACITY

HCPCS
E0154

#1198

Universal Platform Walker/Crutch Attachment

- Designed for those who are unable to grip the walker
- Cradles forearm with soft vinyl padding for comfortable weight bearing
- Universally adjustable
- Adjustable strap securely holds arm in place
- Fits most manufacturers walkers

#1198 Universal Platform Walker/ Crutch Attachment



NEW!

Walker Glides

- Easy to install, simply insert into walker leg
- Fits 1" leg tubing

#1001

1001 Walker Glides (pair)



#1001A

#1001A Universal Walker Glides (fits 7/8" & 1" tubing) (pair)



NEW!

Walker Coaster Glides

- Replace tennis balls, wheels and rubber tips on walker legs
- Easy install: remove existing cover and press firmly to insert coaster center inside 1" standard tubing

#1016 Walker Coaster Glides (pair)

NEW!



Walker Tray & Storage Caddy

- Fits standard folding walkers
- Attaches easily with side straps
- Removable top for storage of personal items
- Heavy duty plastic - cleans easily
- Size 15-1/2" w x 11-3/4" d x 5" h

#1014 Walker Tray & Storage Caddy



#1212B



#1212R

NEW!

Walker Tray

- Durable heavy duty plastic tray
- Fits securely on side-bars of any standard walker
- Raised edges and 2 recessed cup holders

#1212 Walker Tray 21" x 16" (Gray)

#1212B Walker Tray, (Blue)

#1212R Walker Tray (Red)



#1017

#1017 Universal Wheelchair Backpack

Universal Wheelchair Backpack

- Convenient heavy duty storage for standard wheelchair
- 2 large pockets, 2 side pockets
- 14" w x 13" h x 6-1/2"

NEW!



Padded Walker Seat

- Padded seat fits most walkers
- Attaches easily with hook & loop fasteners
- Supports up to 250 lbs.
- Washable leather like cover

#2085 Padded Walker Seat (24" x 8" x 3")

Flips down to sit - up when walking!

HCPCS E0156



NEW!

Multi-Purpose Organizer

- Perfect for walkers, wheelchairs, rollators, etc.
- Multiple storage pockets on both sides
- Extra wide zippered pockets
- Hook and loop closure
- Water proof neoprene, washable

#1027 Multi-Purpose Organizer
8-1/4" x 10-1/2"



#1014

Universal Walker Basket

- Universal Snap on brackets
- Vinyl coated wire basket resist rust
- Vacuformed plastic tray for bottom of basket with cup holder

#1014 Walker Basket 16" x 6" x 7"

HCPCS E1399

NEW!



Oxygen Tank Holder for Wheelchairs

- Designed to hold D & E tanks
- Heavy duty waterproof nylon
- Holder off center for user comfort
- Quick release buckles to remove

NOW AVAILABLE IN BLACK OR BURGUNDY

#2088 Oxygen Tank Holder

PERFECT FOR SCOOTER & WHEELCHAIR ARM RESTS & WALKERS



#1018B

Universal Quilted Pouch*

- Large 15 1/2" x 11" pocket
- Two inner 4" x 5" pockets
- Attractive fancy prints (blue, red, black)
- Designed to fit walkers and wheelchairs
- Machine washable 14" x 16"

#1018 Universal Quilted Pouch*

***Available in Fancy Prints**
Add FRD or FBK to Item Number #1018 or #1025



FANCY RED
FRD

FANCY BLACK
FBK



#1025

Quilted Mini Walker

- Attractive fancy prints (blue, red, black)
- Fits all tubular products
- Features front and back pockets
- Hook and loop closure
- Machine washable 9" x 12"

#1025 Quilted Mini Walker Pouch*



NEW!

#3123

Cup 'n Stuff Holder

Ideal for Wheelchairs, Scooters, Walker, etc.

- Insulated pocket
- Two exterior mesh pockets
- Attaches easily with hook & loop strap
- 3.5" x 5.5" H x 3.5" D

#3123 Cup 'n Stuff Holder

Deluxe Wheelchair Organizer **NEW!**



- Secures easily to back of any wheelchair
- Nine separate pockets for total storage
- Completely washable red on black poly cotton blend

#1149 Deluxe Wheelchair Organizer
(17" W x 19 1/2" T)



#1037

Denim Carry-All

- Washable Blue denim
- Attaches with Velcro closure and tapes ties
- Large main compartment for books, etc.
- Three additional pockets in front
- Size 13" L x 9 1/2" H

#1037 Denim Carry-All



#1015

Universal Denim Pouch

- Designed to fit walkers and wheelchairs
- Blue denim fabric with straps and velcro
- Two inner pockets, machine washable
- 12" x 14" x 13-1/2"

#1015 Universal Denim Pouch



#1146

Wheelchair Carry All

- Fits easily over wheelchair handles
- Heavy duty smooth vinyl finish
- Totally waterproof & stain resistant
- Easy pull zippers with top and middle compartments
- Colors: Maroon or Black
- 4-1/4" x 14" x 14"

#1146 Wheelchair Carry All



Fleece Armrest and Pouch

- Attaches easily with hook and loop fastener over wheel chair arms
- Comfort plus convenient storage
- Blue denim with fleece-covered armrests

#1019 Fleece Armrest and Pouch (one pair)



#1023

Wheelchair Wheel Pouch

- Large outer pouch carries reading materials, clothing articles and personal items
- Inner pouch secures cell phones, remotes and valuables in any of the three secure pouches
- Quilted, machine washable fabric attaches to most any wheelchair with secure hook and loop fasteners

#1023 Wheel Pouch



#1116
Ergonomic Palm Grip Cane

- Unique molded grip
- Directs users weight for stability
- Black aluminum adjustable shaft
- Shaft adjusts from 28" to 36"
- Available in left or right hand

#1116 Right Palm Grip
#1117 Left Palm Grip



Fancy Offset Handle Adjustable Canes

- 1" anodized aluminum
- Adjusts from 31" to 40"
- Wrist strap and silencer
- 300 pound weight capacity

- #1108FBK Fancy Black Paisley
- #1108FBL Fancy Blue Paisley
- #1120B Black
- #1120P Purple
- #1120G Green
- #1120F Fuscia

#1108FBL

HCPCS E0100



#1121 Offset Hand Grip Replacement (Black)



T-Handle Fancy Adjustable Canes

- 1" anodized aluminum
- Adjusts from 31" to 40"
- Wrist strap and silencer
- 300 pound weight capacity

- #1109FBK Fancy Black Paisley
- #1109FBL Fancy Blue Paisley

#1109FBK #1109FBL

HCPCS E0100



Aluminum Canes

- Height adjustment - 31" - 39"
- Available in Offset or Standard

Offset Handle Models

- #1095 Gray Vinyl Grip, Silver Shaft
- #1096 Black Vinyl Grip, Black Shaft
- #1097 Black Foam Grip, Bronze Shaft with Wrist Strap

Curved Handle Models

- #1098 Ladies' Style
- #1099 Gray Vinyl Grip, Silver Shaft

HCPCS E0100



Lucite Deluxe Clear Cane

- Heavy duty acrylic
- Clear finish - 37" long
- Reinforced Tip

#2003 Deluxe Clear Cane

NEW!



Sit & Rise Cane

NEW!

- Adjustable aluminum cane (31-1/2" - 40-1/2")
- Weight capacity - 250 lbs.
- Features two easy-grip foam handles - makes it easy to sit and rise.
- Black or Bronze

#1196 Sit & Rise Cane

HCPCS E0100



Adjustable Folding Canes

- Anodized aluminum finish
- T-shaped handle
- Folds easily for travel or storage
- Height adjustment - 31" - 37"
- Convenient carry and display pouch

- #1086 Bronze
- #1094 Black
- #1105FBK Fancy Black Paisley
- #1105FBL Fancy Blue Paisley
- #1194 Fancy Cane Bag (Available in Red, Blue or Black Fancy)

HCPCS E0100

#1094

#1194

Derby Designer Wood Canes



- 36" length
- 7/8" in diameter
- Extra sturdy
- Six stylish choices
- Firm gripping, rubber tip

**#1106DP - Deal Pack
Six Assorted Units
(Canes may also be
ordered individually)**

**HCPCS
E0100**

Ergonomic-Pivot Walk Easy Cane



- Unique design can be used on any surface and stair climbing
- Ergonomic hand grip
- Large foot pad spreads weight
- Cane pivots for greater stability
- Durable Steel construction
- Adjusts from 33" to 37"
- Weight capacity 300 lbs.

**#1107 Ergonomic-Pivot
Walk Easy Cane**



**HCPCS
E0100**

Rose Handy Seat & Walking Stick

- Lightweight durable anodized aluminum
- 34" tall, 21" seat height
- Folds flat and holds up to 250 lbs.
- Weighs 28 ounces



**#1085 Rose Handy Seat
#1085C Fleece Seat Cover**

**HCPCS
E0100**

Wood Laminated Canes

- 37" long, 7/8" width

**#1111 Walnut
#1112 Rosewood**

**#1113 Natural
#1114 Ebony**



Cane/Sling Seat

- Dual purpose cane and seat rest
- Aluminum bronze frame
- Nylon seat - 18"x8"
- Foam grip handles
- 34" tall, seat to floor height-22"

#1132 Cane/Sling Seat

**250 LB
WEIGHT LIMIT**



**HCPCS
E0100**

Adjustable Cane Seat

- Light weight, durable aluminum
- Folds into a walking stick
- Overall weight: 2 lbs
- Walking height: 34"-38";
Sitting height: 18"-21"
- Seat dimensions: 8"x10"

**#1085B Adjustable
Cane Seat**



Cane Stabilizer Tip

- Lightweight, sturdy rubber tip suitable for most canes
- Compact design allows ease of use on stairs
- Easily navigate uneven terrain or loose surfaces
- Base features non-slip, enhanced traction design
- Stands on its own-no more retrieving fallen canes!
- Enhances user stability, and reduces fatigue associated with stress impact to hand, wrist and elbow

**#1118 Cane Stabilizer Tip
4" W x 4" L**



Safety Cane Tip



- Self standing base (3")
- Greater stability on wet or dry surfaces
- Attaches easily to most aluminum canes
- Unique design creates complete gripping action of base - regardless of angle
- Base 3" high for maximum stability



**NEW &
IMPROVED
DESIGN**

#1119S Safety Cane Tip



Low Profile Quad Canes

- Anodized 7/8" aluminum shaft, silver or bronze finish
- Low profile steel base, chrome, gray or black finish narrow 6" x 8" or wide 8" x 12"
- Offset handle, molded gray vinyl or black hypalon foam handgrip
- Spring button height adjustment
- Safety lock silencer ring
- Reinforced rubber tips
- Height adjustment - 29" - 38", Shipped 2 per carton, 7 lbs.

HCPCS
E0105

Small Base

#1090 Silver
#1092 Bronze (Black Base)

Large Base

#1091 Silver
#1093 Bronze (Black Base)

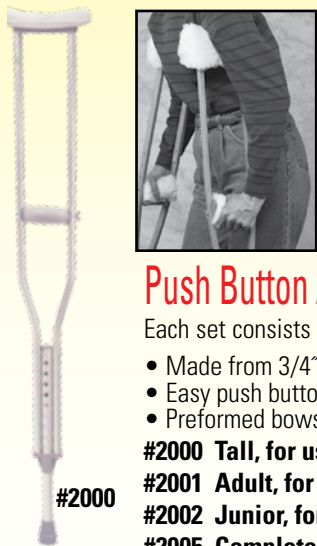

#2000

Fleece Crutch Pad Set

- Soft 1" thick synthetic fleece.
- Machine washable.
- Set - pair arm and grip pads

#3010 Fleece Crutch Pad Set



Push Button Aluminum Crutches

Each set consists of Crutches, Tips, Arm & Handgrips

- Made from 3/4" anodized tubing
- Easy push button adjustment with user height scale
- Preformed bows maintain their shape during adjustment

#2000 Tall, for user height 5' 10" - 6' 6"

#2001 Adult, for user height 5' 2" - 5' 10"

#2002 Junior, for user height 4' 7" - 5' 3"

#2005 Complete Set of Pads, Handgrips and Tips

#1102 Large Crutch Tips (#50)

#1103 Jumbo Crutch Tips (#40)

HCPCS
E0114

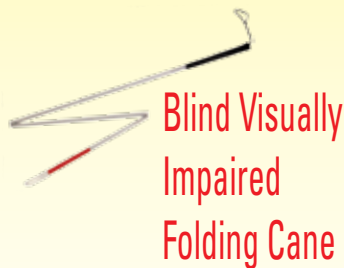

Blind Visually Impaired Folding Cane

- Putter grip, wrist strap and nylon tip
- Red reflective tape on end for added safety
- Available in either 44" or 60" lengths

#2035-44 Blind Visually Impaired Folding Cane 44"

#2035-60 Blind Visually Impaired Folding Cane 60"

Folding Walkcane

HCPCS
E0135

#1008

- Two sure grip hand holds
- Lightweight anodized aluminum design folds easily
- Special angled footpieces provide safety
- Adjustable height from 28" - 33"
- 2 per carton, weight - 9 lbs.

#1008 Folding Walkcane



Crutch Accessory Kit

- Perfect replacements for worn crutch components
- Consists of 2 arm cushions, 2 hand grips and 2 tips (3/4")
- Universal one size fits all.

#2005 Crutch Accessory Kit



#1199

Forearm Crutches

HCPCS
E0110

- Vinyl coated, ergonomic contoured arm cuffs molded for comfort and stability
- Leg and forearm adjust independently
- Hand grips are comfortable and durable
- Extra large tips for added security
- Adjust 28 - 37"

#1199 Forearm Crutches (one pair)
(Fits Adults 5'0 to 6' 2")



Retractable Ice Cane

NEW!

- Double-duty cane provides extra safety
- Steel ice-gripping tip emerges from the bottom of cane
- Bronze anodized aluminum.

#1110 Retractable Ice Cane

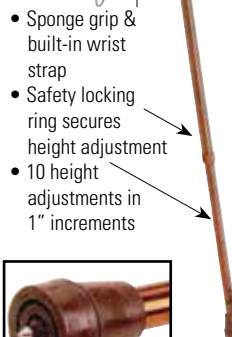

- Sponge grip & built-in wrist strap
- Safety locking ring secures height adjustment
- 10 height adjustments in 1" increments



Ice-gripping tip

Ice Grip Attachment



#1087

- Attaches to any wood or aluminum canes
- Fits most standard crutches
- Unique design lifts up when not in use
- Attaches easily

#1087 Ice Grip Attachment

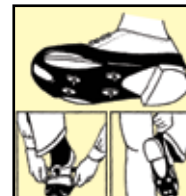

Winter Non-Slip Ice Treads

#1034M (Sizes 6-12)

#1034W (Sizes 5-10)

NEW!



NEW!

Wheelchair Positioner

#2087

- Designed for patient security and good posture
- Fits standard wheelchair and transport chairs
- Black nylon waterproof cover
- Foam meets CAL #117

#2087 Wheelchair Positioner (26" x 3-3/4" x 10")



#1188

Universal Cane Clip

This double clip device can be used for canes as well as many other possibilities. One side can be locked onto a wheelchair via our rubber ring system, the other clip is plastisol coated to grip canes, reachers, etc. 1/pkg.



#1188 Universal Cane Clip



NEW!

#1186

#1187

Fleece Cane Grip

- Unique design enables easy attachment
- Designed to fit wood canes and aluminum canes with wood handgrips
- Hook and loop closure
- Machine washable

#1186 T Handle

#1187 Curved Handle



#3009

HCPCS E1399

Fleece Wheelchair Armrest

- Helps prevent achy arms and elbows
- Attaches easily with hook and loop closure
- Washable poly acrylic fabric

#3009-10 Fleece Armrest 10"

#3009-14 Fleece Armrest 14"

NEW! #3009-10F Fleece Foam Armrest 10"

NEW! #3009-14F Fleece Foam Armrest 14"



NEW!

Comfort Arm Pads

- Durable 2" plush memory arm pads
- Fits easily on any arm rest
- One size fits all - 16" long

#3004 Comfort Arm Pads



Universal Cane Strap

- Attaches to most any wood or aluminum cane
- Long lasting nylon strap

#1089 Universal Cane Strap

#1089



#1088

Non-Slip Cane Holder

- Unique design prevents cane from falling
- Fits all canes
- Holds cane on top or bottom of any shelf or table

#1088 Non-Slip Cane Holder



#2048

Wheelchair Trays

- Ideal for eating, writing and reading
- Raised T-molding on outside edges
- Universal design fits all standard wheelchairs
- Walnut laminate top easy to clean
- Easy to use hook and loop straps

#2048 Adult Wheelchair Tray

24" x 20" x 1/2" 8 lbs.

#2050 Economy Hardboard Wheelchair Tray

24" x 20"



#2046

Clear Acrylic Wheelchair Tray

- Perfect for eating, writing and reading
- Ultra lightweight, highly functional
- Completely transparent for maximum safety
- Universal design fits all standard wheelchairs
- Equipped with hook and loop straps for easy attachment
- 23" x 19" x 1/4"

HCPCS E0950

#2046 Clear Acrylic Wheelchair Tray



#3125

Clamp-On Cup Holder Attachment

- Attaches easily to most wheelchairs and walkers
- Two clips to fit 7/8" and 1" (22 and 25mm) round tubes are included
- The cup holder alone can be easily removed
- No tools required

#3125 Clamp-On Cup Holder

NEW!



Bed Assist Handle

Easy Transfer In and Out of Bed

- Slides between box spring and mattress
- Laminated wood base (19-1/2" x 29-1/2")
- Cushioned hand grip adjusts from 19" to 23"
- Supports up to 300 lbs.
- Perfect for all home style beds

#2108 Bed Assist Handle

Full Length Steel Bed Rails



HCPCS
E0310

#2006

- Easily installed on any 24" to 44" wide hospital bed frame
- Telescopes from 48" to 74"
- Chrome steel 1" diameter tubing
- Clamps feature spring loaded clips and buttons
- Height above spring, up: 16"; down: 1"
- Shipped 1 pair per carton, 33 lbs.

#2006 Full Length Steel Bed Rails

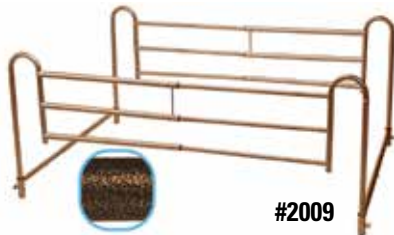

#2009

Home Style Universal Bed Rail

- Powder coated steel for strength and security
- Fits most home style beds including queen and king size beds
- Easily adjusts up or down with spring release
- Easy to install and remove. Adjusts between 36" - 72"
- Weight 30 lbs.

#2009 Home Style Universal Bed Rail



#2019

Protective Bed Rail Pads

- Anti-bacterial, flame retardant and waterproof cover meets CA #117
- Resilient polyfoam center for extra cushioning
- Secure hook and loop fasteners keeps pad in place
- Easy to install and remove
- Size 60"x15"x1/2"

#2019 Protective Bed Rail Pads (Pr.)

#2019F Fleece Protective Bed Rail Pads (Pr.)



#2107

NEW!

Slides between mattress and box spring.



Easy height adjustment.

EZ-Grip Bed Rail Support

- Easy to use - in and out of bed
- Slips between box spring and mattress
- Adjusts from 34" to 45" - Height adjusts from 31" to 37"
- Easy padded grip handle - 20" wide
- Tool Free Assembly
- Powder-Coated Steel
- Fits any size bed

#2107 EZ-Grip Bed Rail Support



Bedside Support Rail

NEW!

- Sturdy bedside rail supports you as you get into bed, then swings away from the bed for assistance.
- Ideal for those transferring from wheelchair to bed.
- Cushion on the top part of the handle for superior comfort.
- Adjusts in height to fit most beds - 32" tall.
- The handle is an oval shape for a perfect grip.
- Installs easily, just slip the steel frame between mattress and box spring and use the safety straps to anchor it securely.

#2007 Bedside Support Rail

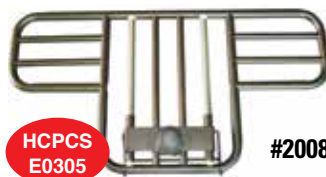

HCPCS
E0305

#2008

#2008 Half-Length Rails

Half-Length Rails

- Fits standard hospital beds with easy action clamp - tool free assembly
- Anodized aluminum 1" diameter tubing
- Overall length: 37"
- Height above spring, up: 16"
- Shipped 1 pair per carton, 14 lbs.

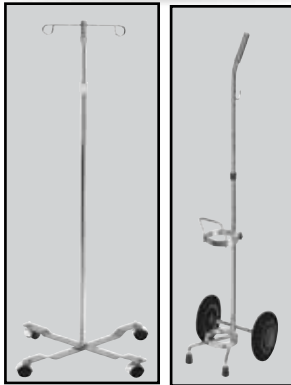

HCPCS
E0776

1028

1029

I.V. Pole

- 4 legs, 2 hooks, Chrome plated steel pole
- Low profile base, Twin wheel swivel castors
- Height adjustment 47" – 85".

#1028 I.V. Pole

Oxygen Cart for D/E and Cylinders

- Plastic tip screw protects cylinder
- Adjustable height handle
- Chrome plated steel 2 per carton

HCPCS
E0776

#1029 Oxygen Cart for D/E and Cylinders



HCPCS
E0910

250 LB
WEIGHT CAPACITY

2038

Overhead Trapeze Sets

- Chip resistant brown vein finish, square tube steel
- Attaches easily and securely to headboard
- Adjustable, overall height: 64" ships UPS
- Provides free-standing support
- Folds flat for storage

2036 Trapeze with Bed clamps

2037 Trapeze Base Only

2038 Trapeze with Base (complete set)

Mattress Clamp and Set

NEW!



#2117

HCPCS
E0809

#2117 Mattress Clamp (Clamp Only)

#2118 Mattress Clamp Set (Velcro Head Halter, Notched Spreader Bar, Rope, 20 lbs Vinyl Bag and Clamp)

#2119 Pelvic Belt (Universal Pelvic Belt) One Size Fit All

#2120 Mattress Pelvic Traction Kit (Universal Pelvic Belt, Rope, 20 lbs, Vinyl Bag, Clamp and Pelvic Belt)

Deluxe Pedal Exerciser

Improved
NON-SKID
Feet

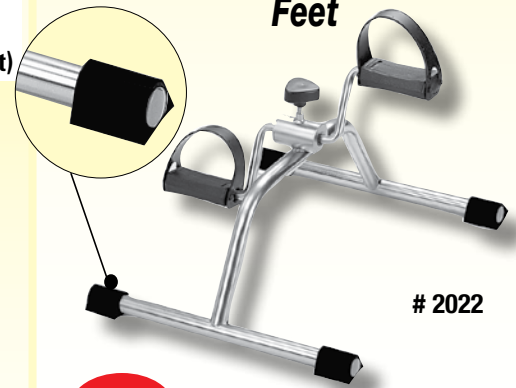

2022

HCPCS
A9300

- Lightweight chrome plated steel construction.
- Easy to follow assembly instructions.
- Disassembles for easy storage and travel.
- Large central knob provides pedal tension.

#2022 K.D. (Knock Down)

#2023 Assembled



2020

HCPCS
A9300

Overdoor Exercise Pulley

- Helps restore shoulder, arm and upper torso mobility
- Includes metal door hanger, plastic hand grips and traction cord
- Comes in retail display box

#2020 Overdoor Exercise Pulley



2018

HCPCS
E0860

Complete Overdoor Traction Set

- Ideal for homecare use when prescribed by a healthcare professional
- Universal self-adjusting, heavy duty hanger and spreader bar
- Adjustable Velcro head halter, one size fits all
- 20 lb. water weight bag
- Comes in retail display box

#2018 Complete Overdoor Traction Set

Assembled & Folding Pedal Exerciser

- Folds in half for shipping and storage
- Opens fully assembled
- Lightweight steel construction - 6 lbs.

#2023F



FOLD TO STORE: Push and hold the button and bend the leg to fold for storage.
UNFOLD TO USE: Pull the leg all the way open until the button pops up to lock in place.

NEW!



HCPCS
A9300

Deluxe Hardwood Transfer Boards

- Easy patient transfer from a wheelchair to a car seat, commode, bed or bath
- Plain or cut-out handle – easy to carry
- Permanent coating for long and easy use
- Lightweight, easy to clean
- 350 lb. weight capacity

- #2040 Solid Hardwood Transfer Board 8" x 24"
- #2041 Solid Hardwood Transfer Board 8" x 30"
- #2042 Solid Hardwood Transfer Board 8" x 30" (Two Cutouts)
- #2043 Solid Hardwood Transfer Board 8" x 24" (Two Cutouts)
- #2044 Solid Hardwood Transfer Board 8" x 24" (One Cutout)
- #2045 Solid Hardwood Transfer Board 8" x 30" (One Cutout)



HCPCS
E0705

350 LB
WEIGHT CAPACITY

Deluxe Heavy Duty Transfer Boards

- 1/2" Birch board
- Tapers at both ends
- Measures 8" x 24" weight 2 1/2lbs.
- Supports up to 450 lbs.

450 LB
WEIGHT CAPACITY



#9051 Deluxe Heavy Duty Transfer Boards

#9051



Plastic Transfer Board

- Made of heavy duty high impact plastic
- Specially molded to ease in moving patient to car seat, bed, commode, or bath
- Compact for travel
- Size - 28" x 8 1/4" x 11/4"
- Weight capacity - 350 lbs.

350 LB
WEIGHT CAPACITY



#2034

#2034 Plastic Transfer Board

Step-Aid

NEW!

- Helps climb steps indoor or out
- Extra large platform (19-1/4"x15-1/2")
- Non-slip design - weather resistant
- Supports up to 440 lbs.

#8002 Step Aid

Portable Curb Ramp

- Portable ramp allows wheelchairs, carts, or vehicles to roll up curbs or steps up to 5.5 inches high
- Great for the handicapped, movers, or delivery personnel
- Durable plastic. Mounting holes on sides and bottom
- 23" wide x 13" deep x 5-1/2" high

500 LB
WEIGHT CAPACITY



#8001

#8001 Portable Curb Ramp

NOTE: 2 units may easily be attached together.

5' Telescoping Wheelchair Ramps

- Universal design - use for steps, curbs and vehicles
- Adjusts easily with push-button locking
- Heavy duty aluminum construction
- Non-skid treads - 3 section design for easy storage
- Size: 7" wide adjusts from 3' up to 5' long
- Weight for set, 14 lbs. - Weight capacity, 650 lbs.

650 LB
WEIGHT CAPACITY



NEW!

#2039 5' Telescoping Wheelchair Ramps with Carry Bag

3-in-1 Commodes

Commode-Safety Rail-Raised Toilet Seat



#1020

HCPCS
E0163

#1020F

- Steel welded frame
- Plastic contour arm rests
- Seat height adjusts 23-1/2" - 29"
- Overall width 20", Seat depth 5"
- Width between arms 17"
- Weight limit - 300 lbs.

#1020 3-in-1 Commode
(two per case)

#1020F 3-in-1 Folding
Commode (one per case)

Folds flat for shipping
and storage

Drop Arm Steel Commode



HCPCS
E0165

300 LB
WEIGHT LIMIT

- Arms drop independently and lock automatically in raised position
- Includes seat and removable 6 qt. pail and lid and splash guard.
- Adjusts 17"-22", width between arms 18.5"
- 1 per carton, 18 lbs.

#1024 Drop Arm
Steel Commode



#1026

Commode Cover

- Turns a commode into a chair
- 100% polyester, water resistant and durable
- Fits any standard commode 18"x15"x7"
- 1" foam pad for seating comfort

#1026 Commode Cover
(Hunter Green)



HCPCS
E0243

Standard Safety Frame

- Anodized aluminum, 1" O.D.
- Locking bracket attaches easily
- Can be lifted off floor for cleaning
- Arm height adjusts 28" - 33"
- Width between arms adjusts 20 - 24"
- 1 per carton, 5 lbs.

#1082 Standard Safety Frame



#1066

HCPCS
E0243

Toilet Safety Rails

- Coated steel brackets white
- Attaches easily to existing toilet seat
- Padded white arm rests
- Width between arms 18"
- 1 per carton, 8 lbs.

#1066 Toilet Safety Rails



#1030

#1032

HCPCS
E0167

Replacement Commode Pails

- Molded plastic with lid on #1032
- Standard on commode's.
- Molded plastic lid with handle on #1030

#1032 6 Qt. Pail 12 per carton, 10 lbs.

#1030 10 Qt. Pail 12 per carton, 13 lbs.

#1033 Splash Guards

Replacement Commode Seats

#1036 Snap-On Seat Assembly

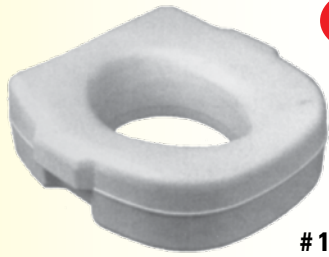

HCPCS
E0244

1046

Deluxe Toilet Seat with Handles

- Raises toilet by 5"
- Easily cleaned
- No installation required
- Packed 3 per carton

#1046 Deluxe Toilet Seat with Handles



#1064

3" Elevated Toilet Seat-Open Front

- Comfort plus height
- Durable easy clean plastic
- Side brackets hold in place
- Fits standard and elongated toilets
- 350 lb. weight capacity

HCPCS
E0244

#1064 3" Elevated Toilet Seat - Open Front



HCPCS
E0244

Elevated Toilet Seat with Removable Arms

- Adds 5-1/2" to seat height
- Front locking mechanism
- Padded arm rests
- Heavy duty plastic
- Seat width - 17", seat depth - 17"
Width between arms 19.25"
Weight limit - 250 lbs.

#1053 - Elevated Toilet Seat with Removable Arms



Toilet Seat with Locking Mechanism

HCPCS
E0244

- Easy hand tightening mechanism safely-secures seat to most toilet bowls
- Lightweight, unbreakable polyurethane, specially molded for sitting comfort
- Raises seat height 5", cleans easily
- 1 per carton, 5 lbs

#1060 Raised Toilet Seat with Locking Mechanism



#1044

Toilet Seat Riser with Arms

- Designed to be used with existing toilet seat and lid, supports up to 300 pounds
- Mounting bolts included
- Raises seat height 3-1/2"
- Large arms for added stability - 19" apart
- Available for standard and elongated bowls

#1043 Standard Bowl
#1044 Elongated Bowl

HCPCS
E0244



#1055

Toilet Seat Riser

- Four piece set elevates seat 3"
- Durable hygienic plastic
- Simple to install - no drilling
- Attaches to existing toilet seat

HCPCS
E0244

U.S. Patent #6,418,566 (Made in USA)

#1055 Toilet Seat Riser



#1040

Padded Commode Cushion

- Comfortable soft seat
- Simple installation with hook & loop straps
- Cleans easily and may be removed to clean
- Firm yet comfortable - contour design

#1040 Padded Commode Cushion 2" Height

#1041 Padded Commode Cushion 4" Height



250 LB
WEIGHT CAPACITY

HCPCS
E0242

#1054

Bathtub Stool

- Sturdy molded polystyrene seat
- Lightweight aluminum frame
- Seat height adjusts 15" - 20"
- Seat diameter 14"
- Reinforced rubber tips
- 2 per carton, 7 lbs. (K-D)

#1054 Bathtub Stool



400 LB
WEIGHT CAPACITY

HCPCS
E0247

#1056

Transfer Bench

- Molded plastic seat and back panels
- Both contoured back rest (17" x 7") and arm rest are reversible for right or left side
- Seat height adjusts 19" - 23", Seat area 26" x 16" with drain holes
- Lightweight 1" aluminum frame
- Reinforced suction feet
- Shipped 2 per carton

#1056 Bath Transfer Bench



300 LB
WEIGHT CAPACITY

HCPCS
E0245

#1057

Padded Transfer Bench

- Soft Cushioned seat and seat back
- Tool free assembly
- Adjustable seat height
- Lightweight 1" aluminum frame
- Suction cup feet
- Shipped 2 per carton

#1057 Padded Transfer Bench

NEW!



#1048

TOOL FREE
ASSEMBLY



#1049

400 LB
WEIGHT CAPACITY

HCPCS
E0245

Deluxe Molded Bath Seats

- Heavy-duty composite construction
- Smooth surface and open water channels
- Easy to assemble-no tools required
- Extra large suction feet for maximum stability
- Seat height adjusts 16" - 21"

#1048 Bath Seat without back 15" x 22"

#1049 Bath Seat with back 15" x 22"



250 LB
WEIGHT CAPACITY

HCPCS
E0245

#1052

Bath Bench with or without Back

- Seats and backs made of blow molded high impact polyethylene – completely closed
- Rustproof anodized aluminum framework, 1" O.D. with sturdy cross-x design to prevent wobbling
- Seat and backrest 12" x 20"
- Seat height adjustment: 16" - 20"
- Backrest height from seat on model 1052, 16"
- Shipped KD, 2 per carton

#1050 Bath Bench w/o back, adjustable (K.D.)

#1052 Bath Bench w/ back, adjustable (K.D.)

NEW!



Folding Bath Bench

- 250 lbs. weight capacity.
- Designed with built-in handles and 10 drainage holes.
- Sure-grip legs provide added safety and stability
- Steel frame is lightweight, durable and corrosion proof. Blow molded seat.

- Overall dimension is 19" (L) x 15" (W) x 20" (H). Leg Base Dimension is 17" (W) x 12.5" (D).
- Fits into all standard 60" x 30" bathtubs.

#1062 Folding Bath Bench / 2 per carton



360° Swivel!

#1042

NEW!

Swivel Bath & Shower Stool

- 16" seat rotates 360°
- Rust proof sturdy plastic
- Adjustable height 18"-20" with sure-grip feet
- Lower tray perfect for accessories
- Mold and mildew resistant
- 400 lb. weight capacity

#1042 Swivel Bath & Shower Stool

Deluxe Bath Bench



#1058

- Lightweight aluminum frame
- Blow molded bench and back
- Corrosive proof with drainage holes
- Armrests for greater comfort
- Seat size, 16" w x 12" d
- Adjustable height legs (16" - 21")
- Packaged 2 per carton

#1058 Deluxe Bath Bench
#1059 Deluxe Bath Bench With Back

250 LB
WEIGHT LIMIT

**TOOL FREE
QUICK
ASSEMBLY!**

HCPCS
E0240



#1059

Floor-To-Tub Bath Rail



#1081

- Attaches easily to side of tub
- Adjusts 4"-6-1/2"
- Extends to floor for maximum support
- 34" height from the floor to top of rail
- Supports up to 250 lbs.

#1081 Floor-To-Tub
Bath Rail

250 LB
WEIGHT LIMIT

Commode Safety Rail



#1045

HCPCS
E1300

300 LB
WEIGHT LIMIT

- Attractive powder coated steel
- Foam-padded handles
- Slip-resistant feet
- Magazine holder
- 24" between handles, 26 1/2" wide

#1045 Commode Safety Rail

Whirlpool Jet Spa - UL®



Variable Control

NEW!

Adjustable
spray nozzle

- Converts any bathtub to a luxurious spa
- Helps ease muscle tension and stress
- Low-voltage 12V motor
- Strong suction cups attach easily to side of tub
- 16 ft. adaptor cord included
- UL® Listed
- 12-1/4" H x 4" Diam.

#1148 Whirlpool Jet Spa - UL®



Chrome Knurled Grab Bars

- 1" heavy gauge steel tubing with 2 1/2" diameter frames
 - Diamond-knurled finish provides secure handgripping surface and years of dependable use
 - Stainless steel hardware included
 - Retail display box
 - Available in 5 different sizes, 12- 32" in length
 - 1" diameter tubing, 1-1/2" from wall
- #1070 12" Chrome Knurled Grab Bar**
#1071 16" Chrome Knurled Grab Bar
#1072 18" Chrome Knurled Grab Bar
#1073 24" Chrome Knurled Grab Bar
#1074 32" Chrome Knurled Grab Bar

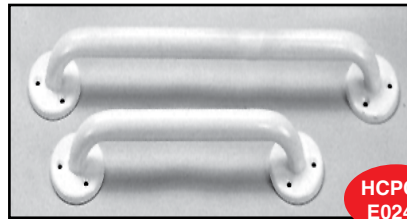

White Grab Bars

- 1" heavy gauge steel construction for improved stability
 - Attractive white powder coat finish provides secure handgripping surface and years of dependable use
 - Stainless steel hardware included
 - Retail display box
 - Available in 5 different sizes, 12- 32" in length
 - 1" diameter tubing, 1-1/2" from wall
- #1076 12" White Grab Bar**
#1077 16" White Grab Bar
#1078 18" White Grab Bar
#1079 24" White Grab Bar
#1080 32" White Grab Bar



Bath Step

Stool holds 400 lbs. weight capacity



- 4" extra height from floor to help in and out of tub
 - Extra wide 16" platform
 - Textured slip-resistant top and rubberized feet to keep firmly in place
 - Additional steps stack securely and - add extra 2" height
- #1069 Bath Step**



Deluxe Hand-Held Shower

- Water spray features easy on/off valve with adjustable flow control
- Reinforced vinyl hose allows spray to reach all parts of user's body while bathing
- Easily attaches to standard 1/2" shower arm
- 54" hose length, with diverter valve
- Wall mounting bracket included

#1038 Deluxe Hand-Held Shower



Tub Safety Bar

- Vinyl coated heavy gauge rust-resistant steel
- Strong one piece steel platform
- Provides stability and comfort getting in and out of bathtub
- Stainless steel locking mechanism with non-marking rubber pads
- Fits a variety of tubs with tool-free installation
- Overall height 19 1/2", clamp adjustment 3-7"
- One per carton

#1084 Tub Safety Bar



Safety Treads

- Easy to apply
- Easy to clean
- Permanent
- Helps prevent dangerous slips and falls

• 20 pieces per package (3/4" x 8 1/2")

#1075 Safety Treads



Non-Slip Soft Hydro Rug For shower or bath

- Unique design enables water to flow thru loofah like poly fibers
- Mildew and stain resistant
- Fast drying - machine washable
- Eight suction cups to hold securely
- 29-3/4" x 17-1/4"

#1063 Non-Slip Soft Hydro Rug

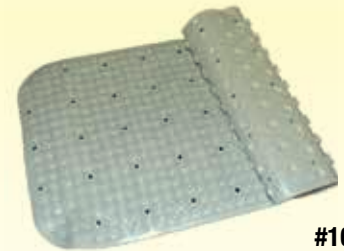

Sure Grip Bath & Shower Mat

- Mildew and mold resistant
- Anti-bacterial treated
- Sure grip safety cups
- Soft white vinyl comfort surface
- Machine washable

#1083 Sure Grip 15" x 35" Bath Mat
#1183 Sure Grip Shower Mat (22" x 22")





#1168



#1167

All Attractively Boxed

Our Best Sellers!

Now Available
In New
Larger Sizes
16" Length
&
24" Length

Sure Suction Tub & Shower Assists



Flip-up easy release tabs help make installation and removal a snap!

HCPCS
E0241

- #1067 Sure Suction Tub & Shower Bar, 12"
- #1167 Sure Suction Tub & Shower Bar, 16"
- #1124 Sure Suction Tub & Shower Bar, 24"
- #1168 Traveler Sure Suction Tub & Shower Bar, 4"



NEW!

Safe-er-Grip™ Foot Rest

- Position at any height for shaving in the shower
- Angled for better balance
- Mounts directly on shower wall
- Easy installation

#1169 Safe-er-Grip™ Foot Rest



NEW!

Corner Safe-er Grip

- Unique design spans corner of tub or shower
- Flip-up easy release tabs for easy installation and removal - (19" long)

#1125 Corner Safe-er-Grip

TubRail Safe-er-Grip

- Raised rail design allows the user to enter a wet and slippery tub safely and with confidence
- Flip-up easy release tabs for easy installation and removal
- Suction cup design is easy to attach, remove or relocate

Attractive Display Box



NEW!

#1184 Tubrail Safe-er-Grip (12-1/2"H, 14"L)

NOTE: All units designed as a balancing assist, not for body weight!

Easy installation and removal

Portable Easy Grip Shower Hose Holder

#1039 Portable Shower Hose Holder

- Easy grip portable shower holder
- Position shower head to any height desired
- Flip-up easy release tab



NEW!

1039

NEW!



Super Grip Suction Bar

Chrome Finish

- Ultra strong seal
- Mount vertically or horizontally
- No tools required
- Red and green color indicators
- Attractive retail display card
- 11.8"L x 3.9"W x 3.5"H

#1142 Super Grip Suction Bar

HCPCS
E0241



Adjustable Angle Suction Bar

#1126 Adjustable Angle Suction Bar - 20" in Length

- Multi-positional "swivel" feature offers a wide range of positioning options
- Allows the user to enter a wet and slippery tub or shower safely and with confidence

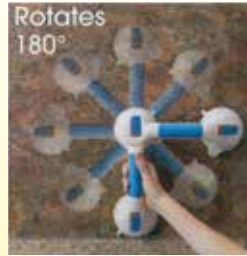

- Flip-up easy release tabs for easy installation and removal
- Red and green color indicators
- Apply to any smooth non-porous surface

HCPCS
E0241



Bath/Safety (#1140)

Grip Alert™

The One Touch Alert System & Suction Assist Bar

Use for assistance, stability, and alerting a loved one when and where assistance is needed.

HCPCS
E0241



Touch the red Alert button to activate Alarm. Audible signal is loud enough for caregiver to hear outside of the bathroom.

Can be used as a portable alert.

With 17" Neck Lanyard

Removes easily from the Grip Alert assist bar providing just one touch to seek assistance, anywhere in the home.

#1140 Grip Alert (9" Long)

Totally Water Resistant • Attractively Boxed • Patent Pending • Made in China • (3AAA Batteries Not Included)

Note - This unit is designed as a balancing assist, not for body weight.



Touch the red Alert button to activate Alarm. Audible signal is loud enough for caregiver to hear outside of the bathroom.

One Touch Alert-Pro System is portable and can be used in any room -- even outdoors!

Perfect for travel use too!

Carry with you or wear around your neck.

17" Neck Lanyard Included

Patent Pending - Made in China

Individually boxed - (3 AAA Batteries Not Included)



Push Alert (#1141)

The One Touch Alert-Pro System

Use for alerting a loved one when and where you need help.

#1141 Push Alert (1-3/4" x 5")



HCPCS E0149

HCPCS E0156

Heavy Duty/Bariatric Rollator

- Soft Foam Grips with patented loop braking system
- 18" padded seat for comfort
- 21.5" between handles
- 8" tires and comfortable backrest
- Foldable for easy storage and transport
- Includes basket for storage
- Weight: 20 pounds

#9001BL
400 LB
WEIGHT CAPACITY

#9001BL Blue (1 Per Ctn.)
#9001BG Burgundy (1 Per Ctn.)



Oversized Aluminum Folding Walker Two Button

HCPCS E0148

- Wider and deeper frame design accommodates individuals up to 500 lbs.
- Vinyl contoured hand grip
- Precision design provides additional strength while adding minimal weight

#9005
500 LB
WEIGHT CAPACITY

#9005 Oversized Aluminum Walker (2 Per Ctn.)
#9000 Bariatric Walker with **NEW!** twin front wheels (2 Per Ctn.)

- Width (Inside Hand Grip) 20"
- Width (Inside Back Legs) 25"
- Overall Width 28"
- Depth (Open at Base) 21"
- Height (Highest Setting) 39"
- Height (Lowest Setting) 32"
- Product Weight 7.0 lbs

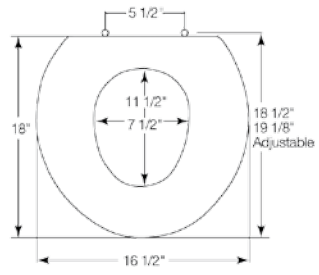

Heavy Duty Steel Base Quad Canes

HCPCS E0105

- Lightweight, extra strong base
- With 1" aluminum tubing, steel base
- comfortable vinyl, contoured hand grips
- Easy-to-use, one button height adjustment from 30" - 39"

#9010
300 LB
WEIGHT CAPACITY

#9010 Small Base, Vinyl Contoured Hand Grip, Chrome Cane (2 Per Ctn.)
#9011 Large Base, Vinyl Contoured Hand Grip, Chrome Cane (2 Per Ctn.)



Heavy Duty Offset Handle Canes

- Comfortable vinyl hand grip with wrist strap
- Manufactured with 1" steel tubing
- Dual push button release allows for handle height to be adjusted

HCPCS E0100

#9015
500 LB
WEIGHT CAPACITY

#9015 (Adult) Black, Adjusts from 27 3/4" - 36 3/4"

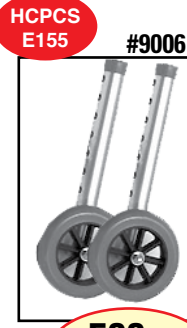

HCPCS E155

#9006

500 LB
WEIGHT CAPACITY

Bariatric Heavy Duty Walker Wheels with Glide Caps

5" Heavy Duty Wheels, Gray Wheels, 1pr/bx

- Converts heavy duty walker into wheeled walker
- Allows for 8 height adjustments
- Dual, rubber wheels allows walker to roll easily and smoothly over irregular surfaces

#9006 Bariatric Heavy Duty Walker Wheels



Bariatric Oversized Toilet Seat

- Fits either standard or elongated toilet bowls
- 1 1/2" wider in diameter than regular sized units
- Fits snugly; seat opening same as standard unit, however, outside diameter is bigger
- Made of sturdy, easy-to-clean white polypropylene
- Closed front with cover, fits all toilet bowls

500 LB
WEIGHT CAPACITY

#9035 Bariatric Oversized Toilet Seat

*See page 9 for Heavy Duty Transfer Boards



Universal Car Seat Belt Extender

- Comfort & Safety
- Adjusts to add 12" to length
 - Shoulder restraints remain intact
 - Meets Federal Motor Vehicle Standards (FMVSS) #209 & #302 approved
 - Black or Gray

#1011 Universal Car Seat Belt Extender



ALL NEW!

Deluxe Heavy Duty Bath Bench with Dual Frame Brace

- Manufactured with 1" Aluminum tubing
- Frame has width/depth cross braces attached with aircraft type rivets
- Large 16" seat depth
- Durable, blow molded plastic bench
- Drainage holes reduce slipping
- Extra middle legs for added strength

#9058 Bath Bench Without Back

#9059 Bath Bench With Back

	#9058	#9059
Width (Outside Legs)	21"	21"
Seat Width	17.25"	17.25"
Depth (Outside Legs)	18.75"	18.75"
Seat Depth	16"	16"
Seat (Height Highest)	19"	19"
Seat (Height Lowest)	17"	17"
Product Weight	8.5 lbs	10 lbs



HCPCS
E0168

9021

650 LB
WEIGHT CAPACITY

Deluxe Bariatric Drop Arm Commode

- Features independent drop arms for easy transfers
- Durable steel construction supports 650 lb.
- Complete with seat, lid, bucket and cover
- Seat size 18" x 23"
- Adjusts 27" x 32"
- Width between arms, 23"
- One per carton - 25 lbs.

#9021 Deluxe Bariatric Drop Arm Commode

HCPCS
E0248



#9058

600 LB
WEIGHT CAPACITY



8-1/4"
9080

500 LB
WEIGHT CAPACITY

Extra Wide Folding Step Stool

- Extra large 19" x 14-1/2" Platform
- Anti-tip design for stability and support
- Folds flat - 2-1/2" for easy transport and storage
- Special non-slip gripper strips
- Sturdy steel construction - 11 lbs.
- 500 pound weight capacity

NEW!

#9080 Extra Wide Folding Step Stool

#9080HR Extra Wide Folding Step Stool with Handrail (16" W x 20" L x 38" H)

NEW!

Heavy Duty Foot Stool

- Manufactured with 1" chrome plated steel tubing
- Non-skid ribbed rubber platform
- Cross brace attached with aircraft-type rivets
- 500 pound weight capacity

#9004 Heavy Duty Foot Stool



9004

9"

500 LB
WEIGHT CAPACITY



500 LB
WEIGHT CAPACITY

#9032

Padded Swivel Seat Cushion with Carry Strap

- Helps prevent back and hip strain
- Designed for a car or chair
- Soft 1" foam padded seat
- Rotates 360 degrees in either direction
- Available in gray velour or fleece top

#9032 Bariatric Swivel Seat Cushion

#9032F Bariatric Swivel Seat Cushion with Fleece Top

Deluxe Heavy Duty Transfer Bench with Dual Frame Brace

- 3 position back depth is adjustable from 18" - 19" in 1/2" increments
- Manufactured with 1" aluminum tubing
- Durable, blow molded plastic bench and backrest

#9057 Heavy Duty Transfer Bench (2 Per Ctn.)

Width (Outside Legs)	32"
Seat Width	27"
Depth (Outside Legs)	22.25"
Seat Depth	16"
Seat (Height Highest)	21"
Seat (Height Lowest)	16"
Product Weight	14 lbs
Carton Shipping Weight	33 lbs



HCPCS
E0248

#9057

400 LB
WEIGHT CAPACITY



Deluxe Alternating Pressure Pump & Pad

- High capacity output 7.0 liters
- Adjustable Pressure range 40-90 mmhg
- Cycle time 5 minutes
- 10 ft. power cord
- On/off switch
- Built in bed mount hooks

HCPCS E0181

#7000 Deluxe Alternating Pressure Pump & Pad

#7000E Economy Alternating Pressure Pump & Pad



NEW!

Sitting Stepper

- Easy exercise - gentle rocking motion
- Helps increase blood flow, reduces leg swelling, numbness and leg cramps
- Durable light weight - folds for travel
- 10-1/2" w, folded - 5-1/2"

#2058 Sitting Stepper



NEW!

Sit-N-Stroll Deluxe Foot Exerciser

- LCD displays steps taken, calories burned and time spent exercising
- Roomy, slip-resistant foot plates
- Easy-adjust tension
- 5 lbs.

#2011 Sit-N-Stroll Deluxe Foot Exerciser



HCPCS A4640

#7001

Alternating Pressure Pads

- Heavy duty 16 gauge PVC
- 2 1/2" height (inflated)
- 78" x 34"
- End flaps secure pad under mattress
- 130 interlocking bubble cells
- Air exchanged every 5 minutes

#7001 APP Pads



NEW!

#3154

Wheelchair Lap Tray

- Uniquely designed to rest securely on the lap to hold beverages and food.
- Made of sturdy wipe-clean molded plastic
- Tray measures 16-1/2" L X 7-1/2" W
- End-Pockets comfortably hugs the legs

#3154 Wheelchair Lap Tray

U.S. Patent #376928 (Made in USA)



NEW!

#3156

Rigid Plastic Bed Tray

- Perfect surface for eating, writing or reading
- Two side storage compartments
- Easy clean - durable plastic
- Tray surface: 13-1/2" x 10-1/2"
- Overall: 23" x 11-3/4" x 8"
- Tray height: 8"
- Attractive ivory color

#3156 Plastic Bed Tray

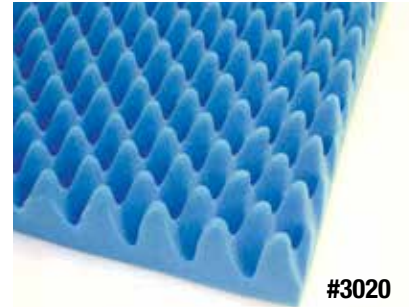

#3020

Convuluted Foam Bed Pads

HCPCS E0199

- Medical grade foam – shrink wrapped
- Meets CA. #117 fire requirements
- Designed for comfort and air flow

- #3020 Convuluted Foam Bed Pad 33" x 72" x 2"
- #3023 Convuluted Foam Bed Pad 33" x 72" x 3"
- #3024 Convuluted Foam Bed Pad 33" x 72" x 4"
- #3021 (Full) 53" x 75" x 2-1/2"
- #3022 (Queen) 59" x 79" x 2-1/2"
- #3028 (King) 75" x 79" x 2-1/2"



#2030



Rose Uplift Seat Assist With Extra Fleece Cover*

- Self-power pneumatic cushion for use on any chair or sofa
- Assists with gentle up or down motion
- Completely portable with carry handle
- Strong enough to lift up to 80% of patient's weight
- Navy removable washable cover

- **#2030 Rose Uplift Seat Lifter (80-230 lbs.)**
- **#2032 Rose Uplift Seat Lifter (195-350 lbs.)**
- **#2032P Rose Electrical Power Seat Assist (300 lbs.)**

HCPCS E0629

HCPCS E0628

- **#2030E Rose Easy Economy** Seat Lifter (80-220 lbs.)**
- **#2032E Rose Easy Economy** Seat Lifter (185-340 lbs.)**
- ****NOTE: NOT COVERED BY MEDICARE**
- **#2032F Fleece cover for uplift seat**



#2004
250 LB
 WEIGHT LIMIT
 HCPCS
 A9270

#2004HR

Foot Stool Foot Stool with Safety Support Hand Rail

- Welded steel chrome plated construction
- Slip resistant ribbed rubber platform
- Reinforced rubber tips
- Platform; 10" x 14" Platform height; 9" Handle height; 34" Overall dimensions; 16" x 12" x 34"

#2004 Foot Stool
 #2004HR Foot Stool
 with Hand Rail

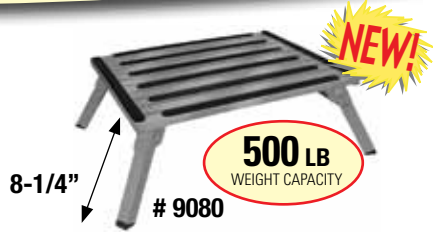

Extra Wide Folding Step Stool

- Extra large 19" x 14-1/2" Platform
- Anti-tip design for stability and support
- Folds flat - 2-1/2" for easy transport and storage
- Special non-slip gripper strips
- Sturdy steel construction - 11 lbs.
- 500 pound weight capacity

#9080 Extra Wide Folding Step Stool
 #9080HR Extra Wide Folding Step Stool
 with Handrail (16" W x 20" L x 38" H)



Heavy Duty Foot Stool

- Manufactured with 1" chrome plated steel tubing
- Non-skid ribbed rubber platform
- Cross brace attached with aircraft-type rivets
- 500 pound weight capacity

#9004 Heavy Duty Foot Stool



#3240

Tote'n Bag Ergonomic Cart

- Lightweight steel for durability (4 lbs.)
- Folds for compact storage
- Ergonomic comfort grip handle
- Water-resistant fabric - blue
- Open dimensions: 13" l x 14-1/2" w x 37" h

#3240 Tote'n Bag
 Ergonomic Cart



Extra Long
 Height
 Adjustment

#3048

Adjustable Blanket Support

- Attractive lightweight aluminum, bronze finish
- Support frame adjusts up to 23"
- Base inserts between boxspring and mattress (2 per carton)

#3048 Adjustable
 Blanket Support



3102

Folding Shopping Cart

- Ideal for groceries and laundry
- Large 6" rear wheels and 3" front wheels
- Folds completely for easy storage
- Basket size; 12.5 x 10.5 x 20"
- Weight 9 lbs. weight capacity 100lbs

#3102 Folding Shopping Cart



Universal Home or Hospital Slatted Bed Board

- Made of specially designed hardwood slats
- Designed for hospital and home beds
- Folds completely for easy storage
- 30" x 60" overall size, 11 lbs.

#2052 Universal Slatted Bed Board

#2052

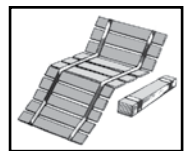

Economy Folding Bed Board

- Four-fold portable bed boards 4 x 15"
- Sturdy 7-ply Triwal board construction
- Attractive white finish - easy to clean



#2055

#2054 Economy Folding Bed Board - 20 x 60"

#2055 Economy Folding Bed Board - 30 x 60"



Wheelchair Transport Bags

(Size 42" x 14" x 35")
 100 per roll

#5038 Wheelchair Transport Bags



#3080

Universal Deluxe Sitz Bath *

- Heavy weight
- On/off flowclip
- 4" x 14 3/4" x 14 3/4"
- Washable

#3080 Universal Deluxe Sitz Bath (10 per case)



#3084

Fracture Bed Pan or Female Urinal *

- Measurements in cc and ounces
- F-3" B-1" x 12 1/2" x 9 1/2"

#3084 Fracture Bed Pan or Female Urinal (10 per case)



#3082

Stackable Bed Pan *

- Stacks easily with grip handles.
- Measurements in cc & ounces
- F-4" B-2" x 14 1/2" x 12"

#3082 Stackable Bed Pan (10 per case)

Bariatric Bed Pan with Cover



#3083

- 350 lb. weight capacity.

#3083 Bariatric Bed Pan with Cover



Individual Poly Bag with Headers - Retail Pack

Following units available in retail package of 10.
#3080, 3084, 3082, 3083, 3086, 3088 - use letter R to denote retail package

Plasticware for Homecare 10 per case Shrink-Wrapped



Female Urinal with Handle

- Uniquely designed for ease of use
- Comes with easy-grip handle
- 1-quart capacity
- Provides visual measurement of contents in ounces or cc's

#3085 Female Urinal (1)



#3046

Unisex Portable Urinal

- Unbreakable polyurethane
- Ideal for bedridden, handicapped and traveling
- Screw-tight lid and female spill-proof adapter
- Holds 28 oz. - 10" long

#3046 Unisex Portable Urinal (1)



#3086

#3088

Female & Male Urinal *

- Clear plastic translucent finish
- Easy grip handles
- 35 oz. capacity (female), 32 oz. male
- Measurement in cc & ounces

#3086 Female (10 per case)

#3088 Male (10 per case)



Unisex Portable Urinal

- Unbreakable white polyurethane
- Easy grip handle
- Flip lid and female adapter
- Holds 28 oz - 800 cc

#3146 Unisex Portable Urinal (1)



Lady Elegance Female Urinal

- Completely hygienic and easy to use
- Can be used any time, any where
- Designed not to flow back, splash, or spill
- Soft, flexible silicone
- Travel pouch included

#3089 Lady Elegance Female Urinal

#3087 Universal Carry Bag for Male/Female Urinals (7-1/2" x 13-1/2") Available in Navy, Fancy Red, Fancy Black



#3000

Fleece Decubitus Bed Pads

- Comfortable, machine washable
- Helps provide better patient care
- Five sizes to choose from
- 100% polyester fiber

HCPCS
E0189

#2998 15" x 18"

#2999 36" x 80" w/ elastic corner strap

#3000 24" x 30"

#3002 30" x 40"

#3006 30" x 60"



#3007



#3008

Heel & Elbow Fleece Pads

- Soft plush protectors
- Hook & loop closures
- One size fits all
- Machine washable

HCPCS
E0191

#3007 Heel Protectors

#3008 Elbow Protectors



#3012-60

Gait Belt

- Safe ambulation
- Quick release plastic buckle
- Easy grip for guiding patients
- Available in 60" or 72" lengths

HCPCS
E0978

#3012-60 Gait Belt 60" Standard Plastic Release

#3012-72 Gait Belt 72" X-Large Plastic Release

#3012M-60 Gait Belt 60" Standard Metal Release

#3012M-72 Gait Belt 72" X-Large Metal Release

NEW!

NEW!



#3103-2

Expanding Doorhinge

- Adds two inches to most any doorway
- Installs easily
- Uses same screws and holes
- Ideal for narrow bathroom doors

#3103-2 Expanding Doorhinge 2 per box

#3103-3 Expanding Doorhinge 3 per box



#4036

#4034

Bed and Chair Riser

- Sturdy 4" or 6" black high density molded plastic with 300 lbs weight capacity
- Elevate head of the bed, increase storage under the bed
- Raises bed height by 4" or 6"
- Can be used on beds, tables or chairs

#4034 Bed and Chair Riser (two - 4" units)

#4036 Bed and Chair Riser (two - 6" units)



Deluxe Gait Belt

NEW!

Support - Stability - Ease of Transfer

- Adjustable - 28"-52"
- Heavy duty nylon straps provide variety of holding positions (6)
- Quick release seat belt buckle
- Hand washable
- 4" high back design

#3030 Deluxe Gait Belt



NEW!



FANCY RED - FRD



FANCY BLACK - FBK

Heel Comfort Pillow

#3016

- Helps prevent and heal decubitus ulcers
- Unique fiberfill is resilient for support and comfort
- One size fits all with hook and loop closure
- Completely washable polyester/cotton cover
- Available in Blue, Fancy Black and Fancy Red

#3016 Heel Comfort Pillow



#3109



#3108

Emergency Call Bells

- Available in a easy to use table top version or wooden handle version
- Ideal for use in bed or bath in case of emergency cases

#3108 Round Call Bell

#3109 Long Handled Call Bell



Deluxe Aluminum Reacher

#2025

- Easy grip plastic handle
- Lightweight aluminum shaft
- Magnetic tip

#2025-32 Deluxe Aluminum Reacher (32")

#2025-26 Deluxe Aluminum Reacher (26")

Easy Reacher

- Lightweight – easy to use
- Rubber cups hold large items up to 3 pounds
- Handy hook and loop hang tag
- Ideal for arthritic hands

#2026 Easy Reacher (Red) (31")

#2027 Easy Reacher (Blue) (31")



#2026

#2027



#2024-32

Super Long 36" Reacher with Rotating Jaw



- New ergonomic handle design reduces hand and finger stress
- New safety locking feature
- Strong anodized aluminum and stainless steel construction
- Heavy duty rubber cup grippers

#2017-36



Ergonomic Reacher with Rotating Claw (18" or 27")

- Lightweight and easy to use ergonomic handle
- Claw rotates 360° with 3-1/2" opening
- Magnet on handle to pick up smaller objects (1130 - 18 & 27)

#1130-18 Ergonomic Reacher, 18"

#1130-27 Ergonomic Reacher, 27"

#1136-31DZ Special Ergonomic Reacher, 31"



Magnets

Claw Rotates Horizontally or Vertically



Magnetic Pick-Up Reacher

- Heavy duty, picks up to 8 lbs.
- Telescopes 6-1/2" - 26"
- Soft comfort grip
- Handy pocket clip

#2134 Magnetic Pick-Up Reacher

Dressing Stick

- 27" long and a strong 5/8" diameter hardwood dowel
- Ideal for persons with limited upper extremity movement or decreased hip flexion
- Vinyl coated push-pull hook on one end and a small "C" pull hook on the other

#3117 Dressing Stick



#3117



#2028

Shoe Horn/Dressing Aid

- 30" long dressing aid with soft foam handle
- Easy to use eliminates bending and stretching

#2028 Shoe Horn/Dressing Aid

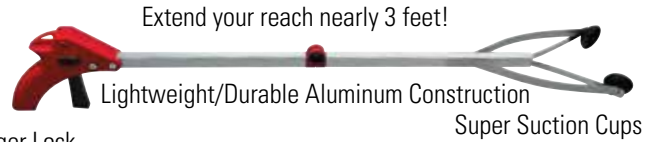

Extend your reach nearly 3 feet!

Lightweight/Durable Aluminum Construction

Super Suction Cups

Trigger Lock

#2021



Folds for easy storage

"Rosie" the Folding Reacher Deluxe Folding Reacher

- Folds in half
- Locking mechanism
- Suction grips

#2021 "Rosie" the Folding Reacher



#3041

Universal No Bend Stocking and Sock Aid

- Rounded edges to prevent snags
- Built in hinges
- Easy glide strips to help your foot slide into sock or stocking
- Built in shoe horn

#3041 Universal Stocking and Sock Aid



Sock Aid with Handles

- Easy grip handles
- Flexible plastic core
- Latex Free



#3044 Sock Aid with Handles

Molded Sock-Stocking Aid



- Unique design holds easily
- Inside nylon reduces friction
- Outside terrycloth holds easily
- Two long loop handles
- Hand Washable

#3052

#3052 Premium Molded Stocking Aid (28" L)



#3032

Easy Leg Lifter/Exerciser



- Aid device to lift feet and legs onto foot rest or into automobiles, beds or for exercise
- Use upper body strength to lift feet and legs
- Perfect for those recovering from hip surgery
- Durable woven nylon with rigid contour and loops at both ends
- Extra hand loop midway for better grip

#3032 Easy Leg Lifter 41" x 1"



#3038

Deluxe Velour Stocking Pull-On

- Velour and nylon covered plastic core
- Easy pull-on loop handles

#3038 Deluxe Velour Stocking Pull-On



Slide Your Foot in and Pull the Handles

Easy Pull Hosiery Aid

- Unique design can be used for compression hosiery, socks, panty hose, etc.
- Place hosiery over contour column and insert foot - pull up on handles
- Sturdy, smooth plastic coating over steel

#3148 Easy Pull Hosiery Aid



Sock Aid Easy On Shoe Horn

- Ideal for those with limited back, knee and hip mobility
- Easy to Use - Doubles as shoe horn
- Works on all socks, knee-highs and compression hose
- Sturdy plastic design, 16" long

#3143 Sock Aid Shoe Horn



Stretchable Elastic Shoe Laces

- Eliminates need to tie
- Easy to slip on/off shoes
- 30" - fits 3-5 hole shoes
- Six pair per package

- #2080 Elastic Shoe Laces Black
- #2081 Elastic Shoe Laces Brown
- #2082 Elastic Shoe Laces White
- #2080VP Variety Pack, 2 Pr. of Brown, Black and White



#3119

Coiler Shoe Laces

- Eliminates the need of tying shoelaces
- Once Coiler Shoe Laces are laced, the excess coiled loops maintain the desired tension
- Fits all shoe sizes
- 54" long



- #3119W Coiler Shoe Laces (white)
- #3119B Coiler Shoe Laces (black)
- #3119BR Coiler Shoe Laces (brown)

NEW!

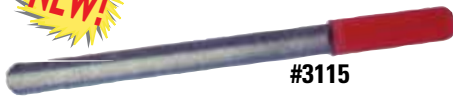

#3115

Easy Slider Shoehorn

The Coated surface makes it easy for the foot to slide into the shoe, and the textured grip handle is easy to grasp. Coated steel. Length is 24".

#3115 Easy Slider Shoehorn



NEW!

Extra Long Handled Shoehorn

- Put on shoes without bending over, 24"
- Large, easy to hold and hang up
- Smooth epoxy coated steel for strength and durability

#3116 Extra Long Handled Shoehorn

#3116



#2033

No Bend Shoe Horn

- 24" long flexible shaft
- Easy grip handle

#2033 No Bend Shoe Horn

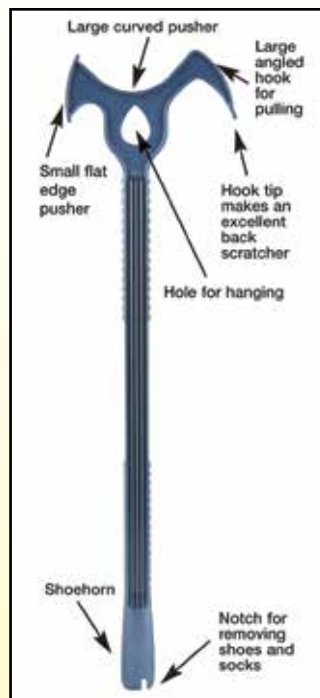

Dressing Stick and Shoehorn

NEW!

- Specially angled large hook holds and pulls clothing without the clothing slipping off
- 2 pushers for removing shoes and clothing
- Long shoehorn with a notch for taking off socks
- 24" (60.96 cm) long

#3153 Dressing Stick and Shoehorn



NEW!



#3118-23

#3118-16

Plastic Shoehorns

Plastic shoehorn with a curved hand grip for easier grasping. Length is 16" & 23". Assorted colors.

#3118-16 Plastic Shoehorn
#3118-23 Plastic Shoehorn



NEW!

Telescoping Shoe Horn

- Extends 10" to 30"
- Angled shoe horn with wrist strap
- Perfect for traveling
- Stainless steel
- Comfort contoured grip

#2133 Telescoping Shoe Horn

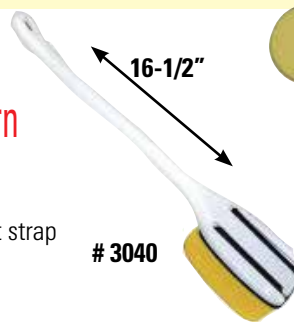

3040

3026

Long Handled Back Sponges

- Ideal for those with limited reach or mobility
- Makes bath easier for caregiver and patient
- #3040 Features Soap Holder

3027

#3040 Back Sponge w/Soap Holder 16 1/2" long
#3042 Curved Handle Back Sponge w/Soap Holder 16 1/2" long
#3026 Extra wide Bendable Ergonomic Handle
#3027 Back Sponge 22" long

Reachers • Sock-Stocking Aids • Bath Sponge • Shoe Horns • Dressing Sticks

Hip/Knee Kits

- Includes all the items needed to recuperate from knee or hip surgery
- Eliminate bending and reaching during recovery period

Private Label Customized Kits Available



Item #2029

#2029

(#2021, #3041, #3027, #2033, #3117)



Item #2029-A

#2029-A

(#2021, #3041, #3027, #3118-16, #3117)



Item #2029-B

#2029-B

(#2025-32, #3041, #3026, #2033, #3117)



Item #2029-C

#2029-C

(#2025-32, #3052, #3026, #2033, #3117)



Item #2029-D

#2029-D

(#2024-32, #3041, #3027, #3118-16, #3117)



Item #2029-E

#2029-E

(#2025-32, #3117, #3118-23, #3027, #3044)



Item #2029-F

#2029-F

(#3041, #3026, #2024-32, #3117, #3118-16)



Item #2029-G

#2029-G

(#3117, #3044, #3115, #2025-32, #2080, #3027)



Item #2029-H

#2029-H

(#3041, #2021, #3117, #3118-23, #3027)



#2025-32



#3117



#3052

Item #2029-J



#2025-32



#3117



#3044

Item #2029-K



#2017-36



#3115



3027

Item #2029-L



#2025-32



#3115



3027



#3052

Item #2029-M



#2025-32



#3115



3027



#3044

Item #2029-N



#2025-32



3027



#3032

i2

Item #2029-O



#2025-32



#3118-16



3027



#3044

Item #2029-P



#2025-32



#3117



3027



Item #2029-Q



#2080VP-1

#3044



#2025-32



#3117



3027



#3044

Item #2029-R

#3118-16



3034



Lotion Applicator

- Easy fill applicator for lotion or gel
- 19 floating balls helps spread lotion evenly
- Detachable handle for massage of arms and legs
- 3 1/2" diameter 17 1/2" long
- Retail display box

#3034 Body Lotion Applicator



#3051

Inflatable Hair Shampoo-er

- Portable vinyl shampooer for bed use
- Inflatable ring acts as reservoir
- Plastic hose allows for drainage
- Folds flat for easy storage

#3051 Inflatable Hair Shampoo-er



#3150

Hair Washing Tray and Spray Attachment

- Soft facing surrounds tray and neck opening
- Compact light weight plastic
- Slip resistant base with nylon strap (35 1/2")
- Drainage outlet
- Size 12 3/4" wide and 17 1/2" long
- Neck opening 4 1/2" wide

#3150 Hair Washing Tray and Spray Attachment
#3150S Spray Attachment



#3058

Inflatable Bed Shampoo-er

- Easy to use heavy-duty vinyl
- 28" wide, 24" long, 6" depth
- Stores flat when not in use

#3058 Deluxe Inflatable Bed Shampoo-er

Handi-Pen Writer



For right or left hand use

- Takes most of the "shake" and muscle pain out of handling a pen
- One finger through the ring creates a solid grip and the ergonomically designed barrel provides a natural resting place for the writing finger
- Barrel fits snugly between the fingers, no pressure, no pain.

#3190 Handi Pen Writer
#3190R Handi Pen Refills (2)



#3107

#3106

Long Reach Brush & Comb

- Ideal for those with limited reach or mobility
- Unique grip, extra soft and comfortable to hold

#3106 Long Reach Comb
#3107 Long Reach Brush
#3107S Comb & Brush Set

GREAT FOR ARTHRITIS OR CARPAL TUNNEL SUFFERERS!



Ergo-Sof Pen

- Ergo design lets natural weight of hand do all the work
- Angle of design helps to write more clearly
- Black ink - refillable (4" l x 1-5/8" w)

#3192 Ergo-Sof Pen
#3192R Ink Refills (2)



Vinyl Meal Time Protector

- 100% vinyl provides total protection from spills and meal time mishaps
- Hook and loop closure
- size 16 1/2" x 35 1/2"

#5018 Vinyl Meal Time Protector, Each
#5018D Vinyl Meal Time Protector, Dozen

#5018



Terry Bib with Moisture Barrier

- Comfortable to wear
- Attractive blue terry cloth 18" x 30"
- Large moisture 12" x 17" barrier provides complete protection
- Easy to use hook and loop closure

#5019 Terry Bib/ Moisture Barrier, Each
#5019D Terry Bib/ Moisture Barrier, Dozen

#5019



NEW!

Patient Protector with Crumb Catcher

- Easy on/off with tie back
- Made of absorbent, durable, white terry cloth face
- Crumb catcher style features a front pouch and waterproof vinyl backing
- Machine washable
- Approximate size: 17-3/4" x 26-1/2"

#5016 Patient Protectors with Crumb Catcher

#5016



NEW!

Smoker's Apron

- Flame retardant fabric
- Prevents accidental ignition of clothing while smoking
- Lightweight and comfortable material
- One size fits all
- White (30" x 34")

#5015 Smoker's Apron

#5015



#3158

Universal Grip Turner

PERFECT FOR THOSE WITH LIMITED HAND DEXTERITY

- Fits over knobs, keys, faucets and odd shaped handles
- Easy grip handle
- Durable plastic with steel prongs

#3158 Universal Grip Turner

NEW!

Clothing Protectors

NEW!



Red - RD

- Full coverage - secures with hook & loop closure at neck
- Waterproof inner barrier with attractive poly/cotton outer
- Size 36" L x 17-3/4" W

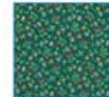

Green - GRN

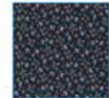

Navy - NV

Specify red, navy, or green

#5011RD,
#5011NV,
#5011GRN



Adult Disposable Bibs

- Size: 16" x 33" - Ply Tissue/Poly
- Slip-on with ties
- Packed 100 per polybag

#5017 Bibs (with tie back)



NEW!

Crumb catcher

#5012

Rose Disposable Clothing Protectors

No Ties! Simply Peel & Stick!
Waterproof, Lightweight, & Comfortable.

- With Fold-Out Crumb Catcher
- Polyurethane Backing
- Display Box - 50 per box
- 13 in x 18 in (33cm x 45.7 cm)

#5012 Disposable Clothing Protectors



#3037

Plastic Food Bumpers

- This sanitary snap-on food bumper is molded in one piece
- Institutional Dishwasher safe
- Fits 8"-11" (20-28cm) plates
- Microwavable
- Adapts a standard plate into a self-feeding plate

#3037 Plastic Food Bumpers



Scoop Plate

- Promotes independence at meal time
- Allows user to push food against high back wall
- Entry side is low for easy use
- Skid resistant base
- Breakproof and microwavable plastic

#3136 White 9" Scoop Plate



Kitchen Gripper

Effortlessly opens any stubborn lid

- Adjustable size jar and bottle opener
- Easy to use dial for most cans or jar lids (from 25-100 mm)
- Built-in pop-top bottle opener
- Extra long handle for extra leverage.



#3139 Kitchen Gripper



“Easy Open It” – 4-in-1 Opener Opens Pill Bottles and Medicine Packaging

- Ideal for arthritic or weakened hands

Two way bottle opener design for pop top caps and for pinching release tabs of Aleve® and Advil® bottles.

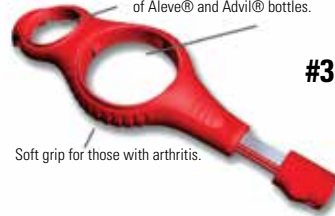

#3138

Soft grip for those with arthritis.

Key hole for use to open Pull Tab caps.



Plastic hook removes cotton from pill bottles.



Slide lock cap provides safety when not in use and locks in place during use.

Individually Carded - 6 Units #3138-DP 6 Pack #3138



Kitchen Magic Opener 6-in-1 Tool



- Multiple assist - ergonomic can opener - opposite end has tools to pry recessed lids, break vacuum seals, remove twist caps, lift tabs and bottle caps.
- Plastic and steel - 8" long

ATTRACTIVE RETAIL PACKAGE

#3157 Kitchen Magic Opener
#3157DP Deal Pack - 6 Units



Ring Pull Can Opener

- Universal design opens ring pull cans - 8-1/2" long
- Ideal for those with limited hand strength
- Dishwasher safe

#3137 Ring Pull Can Opener

#3137

Soft Handled Cutlery

Soft handled, stainless steel utensils have large grips made of closed cell foam which will not absorb moisture. Ideal for people with arthritis or tender hands and finger joints. Foam grip slides off for easy cleaning. Lightweight, dishwasher safe.



- #3200 - Soft Handled Knife
- #3201 - Soft Handled Fork
- #3202 - Soft Handled Teaspoon
- #3203 - Soft Handled Soup Spoon (not shown)
- #3204 - Deal Pack One of Each Above



Top

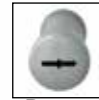

Bottom

Soft Grip Handles



- Unique design allows for inserting utensils, toothbrush, etc.
- Easy to use - on/off handle - to insert
- Perfect for arthritic hands
- Dishwasher safe - thermo plastic material - set of 4

#3250 Soft Grip Handles

Weighted Cutlery

Our comfort grip weighted, stainless steel cutlery weighs 8 oz (226 grams) which decreases hand tremors, allowing cutlery to reach the outh easier. An ideal solution for persons with Parkinson's or other impairments. Latex free. Dishwasher safe.



- #3210 - Weighted Knife
- #3211 - Weighted Fork
- #3212 - Weighted Teaspoon

- #3213 - Weighted Soup Spoon
- #3214 - Deal Pack One of Each



Ergo Grip Utensils



- Easy grip in any position possible
- Provides maximum hand flexibility
- Dishwasher safe plastic
- Set of 3 - Fork, Knife and Spoon

#3216 Ergo Grip Utensils

Recliner Lever Extender



NEW!

- Slides easily over existing handle
- Provides 8" extension over existing handle
- Easy to push back and forward
- Lightweight plastic with soft fabric cover

#3189

#3189 Recliner Lever Extender

Deluxe Lever Extender

NEW!



- Attaches easily to existing lever
- Oversized handle for easy grasp
- Heavy duty steel construction
- 9" l x 7" w

#3196 Deluxe Lever Extender

#3196



#3100 Spill Proof Cup

Spill-Proof Cup

NEW!

- Easy grip handle
- Sturdy screw-on lid that can accommodate straws
- 7 ounce capacity
- Good for hot or cold liquid
- Dishwasher safe



#3134

Universal Button Hook/Zipper Aid

- Can be used with large and small buttons
- 5/8" diameter - polyurethane stained handle
- Easy to use zipper pull

#3134 Universal Button Hook/Zipper Aid



Double Handled Mug

- Ideal for those with a weak grasp or a tremor
- Large handles to accommodate adult fingers
- Wide base to resist tipping
- Dishwasher safe up to 194 F (90 C)
- Lid with mouth piece included

#3035 Double Handled Mug



#1160

A.D.L. Cuff

- Adaptive pocket for everyday utensils
- 1' (25 mm) wide white nylon webbing with hook and loop closure
- For people with hand weakness paralysis but good wrist control

#1160 A.D.L. Cuff



#3036

No Spill Cup

- Features a lid with a mouth piece
- A small air inlet hole in the lid, allows user to regulate the flow of the liquid
- 8oz (235 ml) capacity
- Ideal for drinking while lying in bed

#3036 Convalescent No Spill Cup



3120

3121

3122

English Style Ice Bags

- Wide mouth accommodates even large ice cubes
- Heavy duty with leak proof cap
- Flexible design for easy application

#3120 6"

#3121 9"

#3122 11"



Magnifying Medi-Cap Remover

NEW!

- Built-in magnifier (4X)
- Easy Grip for Smooth or Rigid Caps
- Opens child proof bottles

#3133

Power Putty Hand/Finger Strengthening System

- Flexible silicone rubber can be squeezed, stretched and pulled
- Helps relieve stress and tension
- Recommended by physicians, therapists and sports trainers
- Complete with exercise instructions

#3151M Power Putty (Medium, 3 oz.) (Green)

#3151F Power Putty (Firm, 3 oz.) (Blue)



NEW!

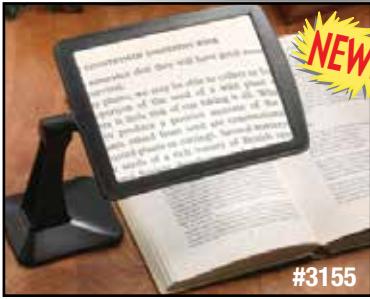

NEW!

#3155

Screen Magnifier

3X-Power Magnifier - Swivels 360°

- Perfect for fine print reading
- Sturdy PVC and ABS Plastic
- Viewing area 4-1/4" x 6-1/4"
- Overall size 9" L, 7-3/4" H x 2-3/4" W

#3155 Screen Magnifier



#3110

Framed Page Magnifier

- Enlarges entire page 4X
- Ideal for reading telephone books, instruction sheets and important documents
- Unbreakable frame and wafer thin lens
- Easy to store and use
- Size: 7 1/2" x 11 3/4"

#3110 Framed Page Magnifier



#3132

Illuminated Bifocal Magnifier

- Features a 3" acrylic lens with 3X magnification and a bifocal insert with 5X magnification
- Requires 2 AA batteries (not included)

#3132 Illuminated Bifocal Magnifier



#3131

Illuminated Magnifier

- 5X magnification
- Illuminates while magnifying
- Hands free design
- Requires 2AA batteries (not included)

#3131 Illuminated Magnifier



Motion Sensor Light

- Lights automatically, no outlet required
- Detects motion up to 10 feet
- Four ultra bright LEDs
- Auto off after 20 seconds
- Mounts easily with peel and stick adhesive
- Lasts 100,000 hours
- Uses 3AAA batteries, not included
- 3-1/4" x 2-3/8"

NEW!

#3184 Motion Sensor Light

Air Purifier/Night Light

Built-in ionizer cleans the air while your family sleeps!

- Uses ultra efficient LED technology
- It's an air purifier inside a night light
- Light turns on automatically in a darkened room
- Plugs into any outlet
- Lasts 35,000 hours - 2 year warranty



NEW!

#3182DP-Air Purifier/Night Light
6 units

#3182-Air Purifier



NEW!

#3145

Handi-Exerciser

- Easy to use hand exerciser
- Strengthens each finger individually
- Ideal for arthritic hand exercises

- Improves dexterity and hand strength
- 4 pounds of resistance per finger
- Ergonomic design with non-slip finger and palm pads

#3145 Handi-Exerciser



Flexion



Extension

Flex-Grip® Hand Exerciser IMPROVES HAND STRENGTH & DEXTERITY

- Strengthens hands, fingers and forearms
- Non-allergenic polymer, latex free, can be heated or cooled
- Dual sided - ball grip and massaging nubs
- Work separately or in tandem
- Perfect for arthritic hands
- Washable. Fits all finger sizes

#3152 Flex Grip® Hand Exerciser

NEW!



NEW!

#3180 Talking Pedometer

Talking Pedometer and Calorie Counter

- Announces how many steps and calories burned and time
- Large LED display
- Attaches to waistband or pocket
- 2-1/4" h, uses 2 button cell batteries, included



Arthritis Relief Gloves

NEW!

- **EASE STIFFNESS** • **RELIEVE PAIN**
- Lightweight half-finger gloves
- Gentle controlled compression, perfect for arthritis and carpal tunnel syndrome
- Stretchable polyamide/spandex blend
- One size fits all

#3164M Arthritis Relief Gloves (Mens, Pair)
#3164W Arthritis Relief Gloves (Womens, Pair)



Compression Gloves

NEW!

Great for: • Arthritis • Tendonitis • Hand fatigue • Carpal Tunnel

- Lightweight and open fingertips
- Unique combination of compression and special gripping nubs
- Helps ease arthritis pain, stiffness and circulation problems
- Cotton/Polyester/Spandex

#3135W Women's Compression Gloves
#3135M Men's Compression Gloves



Hands Free Hair Stand

- Holds hair dryers without the use of hands
- Flexible holder allows for any angle of adjustment while holding dryer securely
- Height adjusts up 34"
- Non-tip weighted stand

#3111 Hands Free Hair Stand

#3111



NEW!

Door Knob Gripper

- Stretch over a door knob to produce a soft ribbed surface
- Reduces strength required to open a door
- Can be used for outdoor water faucet handles and kitchen and bathroom taps

#3128 Door Knob Gripper

#3128



Automatic Card Shuffler

- Simple to use – perfect for those with limited hand dexterity
- Holds up to 2 decks – heavy duty plastic
- Works on 2 C batteries (not included)

#3090 Automatic Card Shuffler

#3090



Plastic Card Holders

- Holds up to 15 cards.
- Stand on table or hold in hand
- Organizes hands for easy playing

#3094 Playing Card Holder (set of 2)

#3094



Easy See Playing Cards

- Extra large letters and numerals
- Standard size playing cards
- Plastic coated finish

#3092 Easy See Playing Cards

#3092



Wooden Card Holder

- Enjoy card playing with little effort
- Tiered slots – solid wood base
- Cards easy to see and remove

#3096 Card Holders (set of 2)

#3096

Pop-Up Weekly Pill Organizer

NEW!

- Spring loaded actions
- Contains 7 individual, removable pill organizers each with 4 divided compartments: Morn, Noon, Eve, and Bed
- Double lock compartment closures ensure pills stay put
- Color coded for each day of the week

#3127 Pop-Up Weekly Pill Organizer

#3127DP (12) Pop-Up Weekly Pill Organizers



Pill Cutter/Crusher

- Heavy duty plastic
- Stores pills, crushes them, and provides a drinking vessel

#3045 Pill Crusher & Cutter



#3045

Medi-Timer

NEW!

- Lightweight, easily carried
- 2" x 4" attractive box
- Battery included
- Stores capsules and tablets of any size
- Easy to use timer function

#3130 Medi-Timer



Large Weekly Medication Planner

- Extra large planner has 28 pill compartments
- Each lid has raised letters and Braille identification
- Dishwasher safe, constructed of heavy-duty plastic
- Size: 8-3/8" x 5-5/8" x 1-1/8"

#3129 Large Weekly Medication Planner



#3129

Lighted Magnifying Nail Clipper

NEW!

- Easy to use 3X magnifier
- Bright LED light easy to see
- ABS plastic stainless steel clipper
- 3 button cell batteries included
- Attractive display card

Easy Empty Nail Clip Catcher
Wide, Non-Slip Comfort Grips
Wide Opening for Thick, Hard Nails



#3104 Lighted Magnifying Nail Clipper
#3104DP 6 Unit Counter Display

Massaging Shower Strap

- Stimulating nodules on one side and soft cleansing bristles on the other
- Attractive display box

#3149 Massaging Shower Strap



NEW!

Automatic shut-off

NEW!

Electric Moist Heat Pad

- Quick heat up - 4 heat settings
- Flexible pad with soft cover
- Moist comfort sponge
- 9-foot cord - 40 minute auto off
- Reusable storage bag



HCPCS E0215

#3300 Electric Moist Heat Pad - Standard - 12" x 15"
#3302 Electric Moist Heat Pad - Extra Large - 12" x 24"

Cell Phone Arm Band

- Keeps phone handy and leaves your hands free!
14-1/2" l x 4-1/4" w
- Zippered cell phone pocket
 - Pocket for keys and cash
 - Adjustable hook-and-loop closure

#2084 Cell Phone Arm Band



#2084

Handy Pocket Holder

Ideal For Wheelchair, Scooter or Car

- Perfect for cell phone, glasses, etc.
- Adhesive-back; ideal for wheelchair, scooter or car
- Soft, flexible, durable plastic
- 3" x 3 1/2" x 1 1/4"

#3124 Handy Pocket Holder



Easy Hear Big Button Phone

- Soft-to-loud adjustable ringer
- Large, easy push buttons
- 6' phone cord
- Hearing aid compatible
- Wall mountable

#3126 Easy Hear Big Button Phone



NEW!

Dual Handle Head to Toe Body Brush

- Firm invigorating polypropylene bristles with dual wood handles

- 4 feet long reaches any part of back or legs

#3050 Dual Handle Body Brush

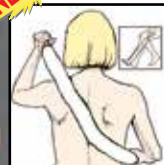

NEW!



Electronic Personal Scale

The Slimmest, Most Compact Scale...Ever!

- Totally Portable, 8-1/4" x 4-1/4" x 7/8"
- Up to 396 lb. capacity (180 kg)
- Large LED display
- Clinical accuracy guaranteed
- Safety tempered glass top
- Requires 2 AA batteries (available anywhere)

#3185 Electronic Personal Scale

TV Listener Ideal for the Hearing Impaired

- Listen to TV without disturbing anyone else
- Volume control on deluxe cushioned lightweight stereo headphones
- No interference from other electronic devices
- Transmits signals up to 50 feet

- Infrared wireless technology
- Works with any TV or stereo
- Uses 2-AAA batteries, not included

#3140 TV Listener

#3140H TV Listener-Extra Head





Auto Assist Grab Bar

NEW!

- No-Slip ergonomic grip
- Spare key compartment
- Window scraper
- Weight Capacity: 300 pounds

#1150S Auto Assist Grab Bar



Hidden Key Holder

NEW!



Soft Swivel Seat Cushion

- Unique design enables easy transfer in and out of automobile
- Soft, comfortable top surface; anti-slip material on bottom
- Conforms to any car seat
- 16" diameter - 2 part cushion
- Weight bearing up to 350 lbs.
- Lightweight, portable

Navy or Camel Cover



#4130 Soft Swivel Seat Cushion



#4030F

Padded Swivel Seat Cushion with Carry Strap

- Helps prevent back and hip strain
- Designed for car or chair
- Soft 1" foam padded seat
- Rotates 360° in either direction
- Supports up to 300 lbs
- Gray velour or fleece cover

#4030 Swivel Seat Cushion



Seat Belt Helper

- Attaches easily to any car seat
- Eliminates straining & discomfort
- Extends reach 6" for ease of use
- Made of flexible silicone

#1164 Seat Belt Helper

The Car Handle

- Installs and removes in seconds
- Fits any framed car window
- Sturdy nylon construction
- Adjustable length (7"-16")
- No-slip rubber ergonomic contour grip

250 LB
WEIGHT CAPACITY

NEW!

#1170



Never struggle to get out of the car again!



Auto Back Seat Hand Grips

NEW!

- Hooks onto back of car headrest posts
- Compact
- Only 13" long
- Made of durable polyester filled PVC for strength and comfort.

#1163 Auto Back Seat Hand Grips



HPCPS
L1902

Elastic Ankle Support

- Designed to maximize compression and provide comfort
- Made of multi-stretch elastic - Biege
- Machine washable
- Features comfortable open-toe and heel
- Available in four sizes based on ankle circumference: S (6" - 8-1/2"), M (8-1/2" - 11"), L (11" - 13-1/2") XL (13-1/2" - 16")

#2070 S, #2070 M, #2070 L, #2070 XL



HPCPS
L1825

Elastic Knee Support

- Design allows for maximum compression and provides comfort and support
- Made of multi-stretch elastic - Biege
- Machine washable
- Available in four sizes based on knee circumference: S (12" - 15"), M (15" - 18"), L (18" - 21") XL (21" - 24")

#2071 S, #2071 M, #2071 L, #2071 XL



HPCPS
L3999

Elastic Elbow Support

- 8" long tubular knitted elastic slips on easily to provide compression
- Made of multi-stretch elastic - Biege
- Machine washable
- Available in four sizes based on elbow circumference: S (8.5" - 10"), M (10" - 11.5"), L (11.5" - 13"), XL (13" - 14.5")

#2073 S, #2073 M, #2073 L, #2073 XL



NEW!

Hot Water Bottle with Stopper

- Seamless rubber
- Leak proof
- Embossed surface
- Capacity: 2 Qts.

#3017 Hot Water Bottle with Stopper

3017



NEW!

Posture Corrector Brace

- Improve posture and ease back strain
- Unique reinforced crisscross foam bands
- Adjustable Velcro® closure
- Contents 80% cotton, 20% Lycra®
- Sizes: S (30"-32"), M (34"-36"), M/L (38"x40"), L (42"-44"), XL (46"-48")
- Machine Washable

#2065 Posture Corrector Brace

HPCPS
L3660



Universal Posture & Clavicle Support

- Soft cotton/flannel back panel and felt padded stockinette shoulder straps
- Front buckle closure makes support universal and allows easy self application
- Pliable metal stays are enclosed for added stability
- Lightweight and discreet under clothing
- Size: (One size fits all up to 44")

#2069 Universal Posture & Clavicle Support

HPCPS
L3660

Combination Water Bottle with Stopper



NEW!

- Screw stopper/auto shut-off clamp
- Complete with vaginal/rectal pipes, hose and adapter

3018

#3018 Combination Water Bottle/Fountain Syringe

Lister Bandage Scissors, Chrome-Plated

ITEM	SIZE
#3160	3-1/2"
#3161	4-1/2"
#3162	5-1/2"
#3163	7-1/4"



NEW!

3160



Magnetic Lumbar Back Support

NEW!

- Low back pain therapy
- 28 integrated high power magnets strategically placed in lumbar area
- Black neoprene with hook and loop closure
- Sizes Small - up to 30"; Medium - up to 38"; Large - up to 46"

#2061 Magnetic Lumbar Back Support

HCPCS
L0625

#2074



Deluxe Industrial Safety Belt

- 8" breathable elastic, double 4 1/2" pull straps
 - 3 flexible metal stays for support and fit
 - Removable and adjustable shoulder strap
 - Completely washable
- Please specify size:
 Small (28" - 33"), Medium (34" - 37")
 Large (38" - 41"), X-Large (42" - 48")
 XXL Large (50" - 54") XXX Large (56" - 60")

#2074 Deluxe Industrial Safety Belt

NEW!



HCPCS
L3660

Lumbar Sacral Support - 7"

- Cool and breathable latex-free elastic construction
- Designed to provide support and compression for lumbar and abdominal area
- Tapered front with 7" back panel
- 4" wide tapered bands to maximize comfort
- Size (waist): S (25"-29"); M (28"-32"); L (31"-35"); XL (35"-38"); 2XL (37"-41")

#2059 Lumbar Sacral Support-7"



PROVIDES
HOT/COLD
RELIEF

Hot or Cold Gel Cervical Collar

- Unique inner gel pack can be heated in microwave or chilled in freezer
- Perfect to relieve tense muscles and ease aches
- Soft poly/cotton cover - removable for washing
- Hook and loop closure adjusts to fit all
- 19-3/4" x 7-3/4"

#2079 Hot or Cold Gel Cervical Collar



HCPCS
L0625

#2060

Lumbar Support Belt With Foam Insert

- Extra support for lower back
- Removable foam insert
- Hook and loop closure
- Completely washable
- One size fits all (up to 48" waist)

#2060 Lumbar Support Belt With Foam Insert



#2072

Universal Blue Neoprene Wrist Brace

- Ideal for sprains, carpal tunnel and arthritis
- Reversible for right or left hand
- Hook and loop closure
- Completely washable
- One size fits all

#2072 Neoprene Hand Wrap



Deluxe Foam Cervical Collar

- Medium density, 1" thick foam collar
 - Covered in natural stockinette
 - Contoured design features chin cutout
 - Velcro-type closure
- Small: 12" - 14" (3")
 Medium: 14" - 16" (3")
 Large: 16" - 18" (3 1/2")
 XLarge: 18" x 20" (3 1/2")

HCPCS
L0120

#2067 Deluxe Foam Cervical Collar



#2068

Universal Foam Collar

- Hook and loop closure
- One size fits all
- Available in 2", 3" or 4" widths

#2068 Universal Foam Collar

HCPCS
L0120

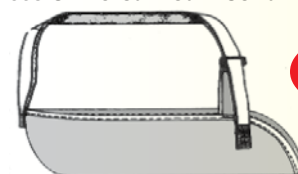

HCPCS
A4565

#2076

Arm Slings

- Attractively Boxed or Bulk Pack

#2076 Poly/cotton w/hook and loop closure (One size fits all)

#2077 Poly/cotton w/buckle closure (One size fits all)



#2063

HCPCS
L0210

#2064

Universal Rib Belt

- Knitted elastic, 6" width, hook and loop closure
- Soft loop material laminated to brush cotton
- Completely washable,
- One size fits all
- Female Rib Belt has front contour

#2063 Universal Rib Belt (Male)

#2064 Universal Rib Belt (Female)

Molded Foam Ring Cushions & Memory Ring Cushions

- Made of a one piece molded foam
- Ring comfortably conforms to body contours
- Ideal for the relief of pain associated with coccyx injuries, hemorrhoids - helps prevent back and hip strain
- Designed to fit most any car seat or chair
- Removable, washable poly/cotton covers, available in three sizes

#4024 Molded Foam Ring 14"

#4025 Molded Foam Ring 16"

#4026 Molded Foam Ring 18"

GEL RING CUSHIONS

#4026GEL 18" Ring with Gel Center **NEW!**

#4026GEL-F (Fleece Cover) 18" Ring with Gel Center **NEW!**

MEMORY RING CUSHIONS **NEW!**

#4025MEM - 16"

#4026MEM - 18"

Please specify: White, Navy, Plaid or Fancy covers



FANCY RED
- FRD



FANCY BLACK
- FBK



TEARDROP
RED - FTD



LEOPARD - LPD



#4022



#4020

Covers Available



#4032

Inflatable Vinyl Ring

- Portable, easy to inflate vinyl ring
- Reduces pain associated with coccyx injuries
- Heat-sealed heavy gauge vinyl for durability

#4022 Inflatable Vinyl Ring 16"

Red Rubber Ring

- Helps relieve pressure and fatigue for those required to sit extended periods
- Made of durable rubber with air release valve

#4020 Red Rubber Ring 16"

#4021 Red Rubber Ring 18"

#4020N Ring & Cover

#4021N Ring & Cover

#4020C Cover Only (Navy)

#4021C Cover Only (Navy)



Convuluted Foam Ring Cushions*

- Helps prevent back and hip strain
- Designed for car seat or chair
- PLEASE SPECIFY: WHITE, NAVY, PLAID, OR FANCY COVER (see above for samples)

#4027 Convuluted Foam Ring 16"

#4028 Convuluted Foam Ring 18"

Deluxe Ring Cushion

- Comfortably conforms to your body
- Cushion helps reduce pressure point discomfort especially when sitting for prolonged periods.
- High-density foam retains its shape and adds support to any sitting surface
- Stylish cover is removable.

#4032 Deluxe Ring Cushion



#3078

HCPCS
2611

All Foam Flame Retardent
Meets Cal. 117

AVAILABLE IN
NAVY, BURGUNDY,
BLACK, GRAY, FLEECE WITH
NAVY & 4 FANCY PRINTS!



Deluxe Molded Foam Lumbar Cushion*

- Molded foam for firm support
- Side "wings" provide extra support
- Removable poly/cotton cover with elastic strap included

#3078 Deluxe Molded Foam Lumbar Cushion 13" x 14"

#3078XL Extra Large Molded Foam Lumbar Cushion 13" x 18"*

#3078F Molded Foam Cushion with Fleece Cover

*Navy, Black Only

#3079 Deluxe Molded Foam Lumbar Cushion Extra Firm with
(Masonite®) Insert 13" x 14"



FANCY RED
- FRD

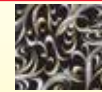

FANCY BLACK
- FBK



TEARDROP
RED - FTD



LEOPARD - LPD



#3078GEL

HCPCS
2611

AVAILABLE IN
NAVY, BURGUNDY,
BLACK, GRAY &
4 FANCY PRINTS!

Deluxe Molded Foam GEL Lumbar Cushion*

- 14"x13"
 - Washable, removable cover
- #3078GEL GEL Lumbar Cushion



LEOPARD - LPD



FANCY RED
- FRD

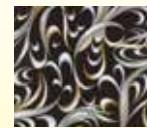

FANCY BLACK
- FBK



TEARDROP
RED - FTD



#3078MEM

HCPCS
2611

Memory Foam Lumbar Back Cushion*

- Removable, machine washable polyester/cotton cover
- Strap keeps cushion in position on most any chair or seat
- Heat sensitive memory foam custom contours and supports natural spinal curve

#3078MEM Memory Foam Lumbar
Cushion 13"x 14"



FANCY RED
- FRD



FANCY BLACK
- FBK

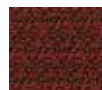

TEARDROP
RED - FTD

AVAILABLE IN
NAVY, BURGUNDY,
BLACK, GRAY &
4 FANCY PRINTS!

VISCO ELASTIC FOAM DEVELOPED by NASA



E2611

Fleece Wheelchair Back Cushion*

- Fleece cover with foam insert
- Maximum comfort
- Provides 2 hang loops for positioning
- Improves air circulation
- Size: 18" x 20"

#4023F Fleece Wheelchair Back Cushion

#4023FM Fleece with Memory Foam Insert



Back and Seat
Cushions

Perfect for all
Wheelchairs

HCPCS
2611



LEOPARD - LPD

Wheelchair Cushions - Standard Foam



#4014

- High density foam for seating comfort
- Fits all standard wheelchairs
- Removable and washable cover

HCPCS 2601

- #4011 18" x 18" x 2" Navy Cover
- #4009 Plaid or Navy 16" x 16" x 2"
- #4014 Fancy, Plaid, Black or Navy 16" x 18" x 3"
- #4015 Plaid or Navy 16" x 16" x 3"
- #4016 Fancy, Plaid, Black or Navy 16" x 18" x 2"
- #4017 Fleece Cover 16" x 18" x 2"
- #4029 Fancy, Plaid, Black or Navy 16" x 18" x 4"
- #4015F 16" x 16" x 3" - Fleece Cover
- #4120 16" x 20" x 3" - Brushed Navy Cover
- #4122 16" x 22" x 3" - Brushed Navy Cover
- #4124 16" x 24" x 3" - Brushed Navy Cover

AVAILABLE IN NAVY, PLAID, FLEECE & 4 FANCY PRINTS!

HCPCS 2602

All Foam Flame Retardant meets or exceeds CAL#117 requirements Made in USA



FANCY RED - FRD



FANCY BLACK - FBK



TEARDROP RED - FTD



#4018

Convoluted Seat Cushion

- Ideal for home, office, car or wheelchair
- Allows for better air circulation to reduce heat build up to reduce the risk of developing decubitus ulcers
- Plaid, Navy, Black or Fancy Print removable, washable cover

- #4018 Convoluted Seat Cushion 3" x 16" x 18"
- #4019 Convoluted Seat Cushion 4" x 16" x 18"
- #3025 Convoluted Full Chair Pad (Foam Only) 18" x 32" x 3"

NEW



LEOPARD - LPD



FANCY RED - FRD



FANCY BLACK - FBK



TEARDROP RED - FTD



HCPCS 2601

#4003

Auto Seat & Wheelchair Sloping Wedge

- Unique design prevents user from sliding forward and helps promote proper posture
- Removable washable cover
- Size 16" x 18" x 3" to 1"

#4003 Wheelchair Sloping Wedge



HCPCS 2601

#4001

Sloping Coccyx Cushion

- Cushion Slopes 2" to help prevent sliding forward and helps promote proper posture
- Coccyx design removes pressure from coccyx area
- Removable, washable navy poly/cotton cover
- Size 16" x 18" x 3" to 1"

#4001 Sloping Coccyx Seat Cushion



HCPCS 2601

#4005

Coccyx Seat Cushion

- Unique design helps relieve pressure on Coccyx Bone
- Removable, washable navy cover polyester/cotton cover
- 100% foam construction for total comfort
- Size 18" x 16" x 3"

- #4005 Coccyx Seat Cushion
- #4005M Coccyx Comfort Cushion with Masonite® Board Insert

Sloping Travel Cushion

- 15" x 14" x 3" to 1 1/2"
- Washable Navy Cover
- See 4101 for features, other than cut-out

#4102N Sloping Travel Cushion



NEW!

Sloping Travel Coccyx Cushion

- 3" U-Shaped opening provides pressure relief for the coccyx tailbone area to help relieve lower back pain
- Constructed of highly resilient polyurethane foam for maximum comfort and durability
- Features a machine-washable, zippered cover with built-in carry handle
- Size 15" x 14" x 1-1/2"-3"
- Covers available in camel & navy
- Foam meets CAL #117 requirements

- #4101C Camel Cover #4101N Navy Cover
- #4101 Waterproof Navy Cover
- #4101M Memory Foam - Navy or Camel Cover

NEW!

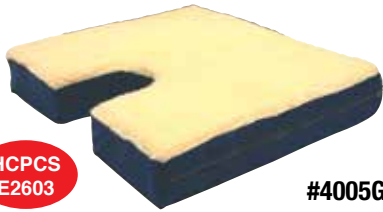

HCPCS E2603

#4005G

Coccyx Gel Seat Cushion - 3 1/2" with Fleece Top

- Cut-out relieves pressure on spine
- 3" high density foam with gel pad in center
- Reduces pressure on tail bone and spine
- Washable, navy cover with fleece top
- Size: 16" x 18" x 3"

#4005G Coccyx Gel Seat Cushion
#4005GN Coccyx Gel Cushion with All Navy Cover

Bariatric Style

- #4005GB 16" x 20" x 3 1/2" (Fleece Top)
- #4005GXL 16" x 22" x 3 1/2" (Fleece Top)
- #4005GXL-N 16" x 22" x 1 1/2" (Navy)

NEW! HCPCS E2607

All Foam Flame Retardant

meets or exceeds CAL#117 requirements

Made in USA

Gel Wheelchair Cushion with Fleece Top - 3 1/2"

- Gel and foam construction provide perfect weight distribution for maximum comfort while you sit

- #3997 - 16" x 16" x 3 1/2" **NEW!**
- #3998WP 16" x 18" x 3 1/2" Waterproof Cover
- #3998G 16" x 18" x 3 1/2"
- #3998N 16" x 18" x 3 1/2" with All Navy Cover

Bariatric Style

- #3996 16" x 20" x 3 1/2" (Fleece Cover)
- #3998XL 16" x 22" x 3 1/2" (Fleece Cover)
- #3998XL-N 16" x 22" x 3 1/2" with full Navy Cover
- #3998XL-WP 16" x 22" x 3 1/2" with Navy Waterproof Cover

NEW!

HCPCS 2607



#3998G

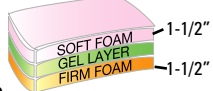

IDEAL POSITIONER AND SKIN PROTECTION

HCPCS 2608

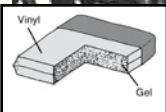

HCPCS E2603 #4012

Pressure-Aid 100% Gel Cushions

- Total displacement of pressure
- Helps prevent decubitis problems
- Gel enclosed in heat-sealed heavy gauge vinyl plus cover

- #4010 Navy Cover 16" x 18" x 2"
- #4012 Fleece Cover 16" x 18" x 2"
- #4013 Navy Cover 16" x 20" x 2"



HCPCS E2607 #4002

Pressure-Aid Gel Cushions - 2-1/2"

- Total comfort with unique combination of gel and foam
- Reversible for soft or firm seat
- Gel sealed in heavy gauge poly bag

- #4002 Navy Cover 16" x 18" x 2-1/2"
- #4004 Fleece Cover 16" x 18" x 2-1/2"
- #4006 Navy Cover 16" x 20" x 2-1/2"
- #4007 Fleece Cover 16" x 20" x 2-1/2"

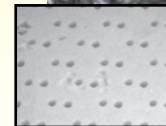

#3099

Natural Pincore Latex Foam Cushion

- Ultra soft latex comfort and support
- Excellent recovery
- Pincore cushion allows for better air circulation
- Removable, washable poly/cotton cover
- Available in Navy, Black, Plaid or Fancy Print cover

HCPCS E2601

#3099-3 Pincore Latex Foam Cushion 16" x 18" x 3"

#3099-4 Pincore Latex Foam Cushion 16" x 18" x 4"



FANCY RED - FRD



FANCY BLACK - FBK

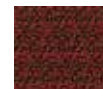

TEARDROP RED - FTD



NEW

LEOPARD - LPD

Prostate Cushion

- Unique design to relieve pressure on perineal area
- Comfort plus relief
- Washable brush navy cover
- Foam meets Cal#117 requirement

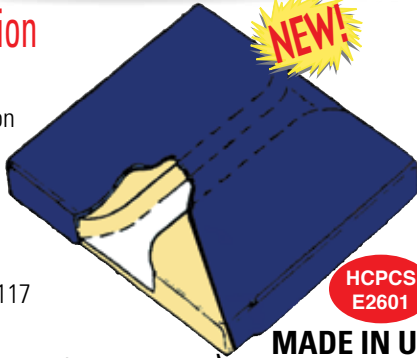

MADE IN USA

#3178 Prostate Cushion (16" x 18" x 3")



Comfort Plus Protection
MADE IN USA

Waterproof/Anti-Bacterial Wheelchair Cushions

- Treated foam meets CAL #117 requirements
- Easy clean vinyl
- Anti-bacterial, anti-static, waterproof cover

- #4014 WP-N Cushions 16" x 18" x 2"
- #4016 WP-N Cushions 16" x 18" x 3"
- #4029 WP-N Cushions 16" x 18" x 4"
- #4015 WP-N Cushions 16" x 16" x 3"
- #4029 WP-NM with Masonite Insert 16" x 18" x 4"

Seat Cushion - Invalid Ring

- Comfort with pressure cut-out in center
- Washable Brushed Navy Cover
- Size 16" x 18" x 3"



MADE IN USA

#3179 Seat Cushion - Invalid Ring



Deluxe Wheelchair Cushion

- Designed to promote proper positioning and skin protection
- Molded foam core - unique contour design
- Fire retardant cover and water resistant. Removable and washable
- Bottom side has slip free surface to remain in place.
- Size: 16" x 18" x 2"

#3800 Deluxe Wheelchair Cushion



Leather Seat Cushion with Lumbar Support

- Ideal for wheelchairs, home or auto
- Soft pliable black leather
- Features include an lumbar support
- Fits any seat size

#4008 Leather Seat Cushion 38" x 18"

#4008



Back and Seat Cushion

- Ideal for wheelchair or use on any chair
- Back cushion (16" x 18" x 2")
- Seat (16" x 18" x 3")
- Removable fleece cover



#4114F Fleece Back & Seat Cushion

#4114FBK Fancy Back & Seat Cushion MADE IN USA

Wheelchair Plush Cushion

- Contours to arms, back and seat for total comfort
- Overstuffed soft fiberfill
- Polycotton plaid cover
- Seat size 16" x 16"
- Back 16" x 22"
- Arm 16" x 18"
- Available in Plaid or Fancy Black



#4115 Wheelchair Plush Cushion

#4115 MADE IN USA

Fold & Carry Cushion

- Soft synthetic fleece seat with velour cover
- An ideal go anywhere cushion
- Seating area 13" x 15"
- Folds to 6 1/2" x 15" with hook and loop closure
- Convenient carry handles

#4000 Fold & Carry Cushion

MADE IN USA





UNIQUE POCKET DESIGN

HCPCS E0199

Space Saver Bed Wedges With Savings on Freight Charges

The Space Saver Bed Wedge with Pocket

- Perfect for head, foot or leg elevation
- White or Blue zippered washable cover with sewn pocket. Holds TV remote, T.V. guides, magazines, and more
- Foam meets CAL 117 requirements

Shipped at its true weight
No oversized charges

MADE IN USA

Available in White or Blue Covers

- #3067SS—Bed Wedge (7" x 20" x 20") Packed two per carton
- #3068SS—Bed Wedge (10" x 20" x 20") Packed two per carton
- #3069SS—Bed Wedge (12" x 20" x 20") Packed two per carton



HCPCS E0199

3-in-1 Bed Wedge with Pocket

- #3067 Bed wedge 7" x 24" x 24" (2 Per Ctn.)
- #3068 Bed wedge 10" x 24" x 24" (2 Per Ctn.)
- #3069 Bed wedge 12" x 24" x 24" (2 Per Ctn.)

#3068FB Fleece Top, Blue 10" x 24" x 24" **NEW!** (2 Per Ctn.)

- Perfect for head, foot or leg elevation
- White or Blue zippered washable cover with sewn pocket holds TV remote, T.V. guides, magazines and more
- Foam meets CAL. 117 requirements
- 2 per case
- Easy carry zippered bag

Available in White or Blue Covers



#3066

Convoluted Foam Bed Wedge

#3066 Convoluted Foam Bed Wedge
10" x 24" x 24" (2 Per Ctn.)

(Replacement covers available, add letter C - denotes cover only)



#3168

Inflatable Bed Wedge

- Heavy gauge white vinyl
- Washable blue dacron/cotton cover
- Size 27" x 27" x 8"

- #3168 Inflatable Bed Wedge
- #3168C Cover Only
- #3168K Bed Wedge and Cover

Perfect For Head, Foot or Leg Elevation

Helps:
Acid Reflux, Sleep Apnea, Snoring Problems, Heartburn, Sinus Drainage



NEW!

Adds 5" of elevation

#3169

The Comfort Wedge

- Graduated elevation to 5" height
- Fire Retardant Polyurethane Foam
- Removable Quilted Poly/Cotton Cover
- Machine Washable - White Cover
- 32" L x 26" W x 5" H

#3169 Comfort Wedge

Helps Relieve:

- Acid Reflux
- Snoring
- Sleep Apnea
- Indigestion



#3072S

Crescent Neck Pillow

- Polyester filled for comfort and support
- Contoured to ease neck and back strain
- Excellent for traveling, home or office
- Hook and loop closure keeps in place
- Removable cover - navy, satin or fleece



#3072F



#3073

Knee Comfort Pillow

- Helps to reduce hip strain while sleeping
- Greater sleeping comfort
- Hook and loop closure keeps pillow in place
- Washable White cover

#3073 Knee Comfort Pillow 7" x 4" x 5"

Deluxe Knee Pillow

Restores natural body alignment

- Molded contour design helps reduce stress on hips, knees and ankles
- Helps to increase circulation in legs and feet
- Removable, washable polyester cotton cover

#3063 Deluxe Knee Pillow 10" x 8" x 5 1/2"



#3072 Crescent Neck Pillow 2" x 12"

#3072F Crescent Fleece Neck Pillow with Fleece Cover (2" x 12")

#3072S Crescent Neck Pillow with Satin Cover



Memory Foam Neck Cushion

- Ideal for travel and relaxation
- Soft plush terry cover, navy
- Removable and washable

#3172 Memory Foam Neck Cushion (3" H)



#3063



Easy Knee and Arm Comfort Pillow Rest

- Helps keep body in alignment
- Designed to ease pain in hips, legs, knees and back
- Easy to use hook and loop straps for perfect positioning
- Fiber fill batting with dacron/cotton cover

#3173 Easy Knee and Arm Comfort Pillow Rest



Inflatable Knee Pillow

- Helps take pressure off lower back, hips and knees
- Adjusts easily for firmness
- Soft flocked surface stays in place
- Folds flat with carry case - for travel or home

#3031 Inflatable Knee Pillow



#3070

Cervical Comfort Pillow

- Provides neck support to relieve pressure and tension
- Use on your side, back or stomach
- Gray, washable, removable cover
- Firm support foam
- Measures 16" x 14"

#3070 Cervical Comfort Pillow



Inflatable Neck Cushion

- Provides neck support and comfort
- Perfect for traveling with handy carry pouch

#3049 Inflatable Neck Cushion



#3113

**Support Plus
161 Massage Tips
Stimulate Pressure Points in Back
Frame Mesh Lumbar Supports**

- Open weave mesh stays cool while providing adjustable support
- Cushions and supports the spine. Helps to reduce lower back fatigue
- Attaches easily, light weight and portable
- Available in Standard or Adjustable frame models (black)

**#3113 Standard Frame Mesh Lumbar Support
3/8" x 15" x 15 1/2"**

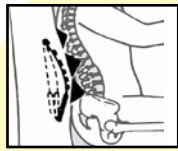

with

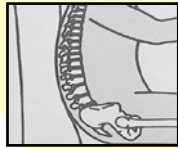

without



Cervical Dream Pillow

NEW!

- Sleep comfort with neck and head support
- 100% Fiber fill with attractive poly-cotton self cover

**#3165 Cervical Dream Pillow
21" x 7-1/2" x 5" Center**



#3061

Memory Foam Pillow

- Heat sensitive foam, contours
- One size fits all – 4" width

#3061 Memory Foam Pillow

NEW!

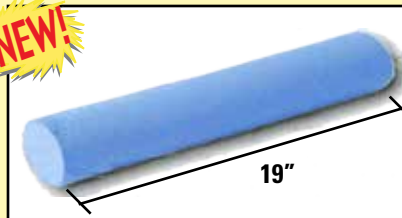

MADE IN USA

#3177

Firm Cervical Rolls

- Ideal for cervical or sacral use
- Removable washable cover
- 19" Length available in 3 1/2", 5" and 7" width

#3177 3 1/2"
#3177 5"
#3177 7"



#3076

#3077

MADE IN USA

Lumbar Back Support Roll

- Seat comfort and back support
- Attaches and stays in place with elastic strap
- Washable navy poly/cotton cover

**#3077 Standard Support Roll
10 3/4" x 4 3/4"**

**#3076 Half Roll Support
10 3/4" x 2 3/8"**

#3175-4 Extra Firm Lumbar Roll **NEW!**
12" x 4"

#3175-5 Extra Firm Lumbar Roll **NEW!**
12" x 5"

#3176-Extra Firm Half Lumbar Roll **NEW!**
12" x 6" x 4"



#3171 Sciatica Cushion

MADE IN USA

Sciatica Cushion

NEW!

- Unique design encases tennis ball with polyester batting
- Attractive brush navy cotton/polyester, soft cover
- Helps relax the Piriformis muscle and relieve stress on sciatic nerve
- Most effective when used in sitting position - placing at the area of pain
- Size - 6" x 10"



#3071

Elevating Leg Rest

- Unique design for knee elevation
- For treatment of phlebitis, varicose veins or tired legs
- Helps to flatten lower spine to reduce lower back pain
- Washable blue denim cover

MADE IN USA

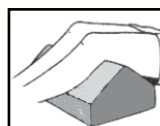

**HCPCS
E0190**

#3071 Elevating Leg Rest 17" x 10" x 7"

#3071XL Elevating Leg Rest 28" x 10" x 7"

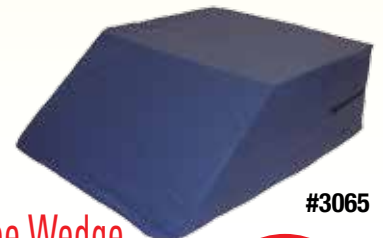

#3065

Ortho Knee Wedge

**HCPCS
E0190**

MADE IN USA

- Navy washable zippered cover
- Elevates legs comfortably
- Promotes circulation to legs
- Helps to flatten lower spine to reduce lower back discomfort

#3065-8 Ortho Knee Wedge 8" x 20" x 25"

#3065-10 Ortho Knee Wedge 10" x 20" x 30-1/2"



HCPCS
E0190

#3060

Convolutd Comfort Pillow

- Perfect support for head and neck
- Special convolutd design promotes better air circulation and relieves pressure
- Keeps user cool and comfortable
- Removable white poly/cotton cover
- Size, 22-1/2" x 16"
- Foam meets CAL 117 requirements
- Ideal for proper alignment

#3060 Convolutd Comfort Pillow



#3062

HCPCS
E0190

Butterfly Orthopedic Pillow

- Therapeutic support for neck and back
- Maintains proper neck and spine alignment
- Polyester fiber filled
- Removable Blue satin cover
- Can be used to elevate knees and calves
- Size 17" x 22"

#3062 Butterfly Orthopedic Pillow 17" x 20"



HCPCS
E0190

#3064

Comfort Plus Pillow

- Special design with polyester filling
- Good for sleeping on back or side
- Helps maintain spinal alignment
- Comfortable white poly/cotton self cover
- Center recess cradles head – bottom keeps neck in proper alignment

#3064 Comfort Plus Pillow 19" x 23"

Replacement covers available on all of our Orthopedic Pillows
Call customer service for more information



HCPCS
E0190

#3074

Cervical Neck Pillow

- Round cervical pillow
- Polyester filled
- Perfect for neck support
- Non-removable poly/cotton cover

#3074 Cervical Neck Pillow 7" x 17"
#3075 White Zippered Cover 7" x 17"
#3075S Satin Zippered Cover 7" x 17"
#3174 Convolutd Neck Pillow 7" x 17"

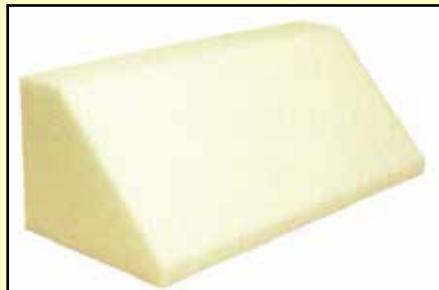

Body Positioner with Navy Cover

- Helps to align and maintain body position
- Ideal for use as wedge or for knee elevation
- Polystyrene foam (24" x 10 1/2" x 8 1/2")
- Meets Cal. 117 specifications

#3019 Body Positioner & Cover



Face Down Wedge Pillow

- Unique design for those who must lay face down for comfort and medical requirements
- Comfort contour enables women to lay flat - reverse side flat for men.
- The face is cradled with spine in correct position
- Polyurethane foam with washable white cover

#3059-17 Face Down Wedge Pillow
(17" x 14" x 6-x 1-1/2")

#3059-29 Face Down Wedge Pillow
(29" x 14" x 6" x 1-1/2")



Comfort Curve Pillows

- Designed for cervical and thoracic support
- Helps to ease neck and upper back strain
- Easy to position for maximum comfort
- Makes an ideal total body pillow

#3053T Comfort Curve Pillow Travel size (14" x 14")
#3053S Comfort Curve Pillow Standard size (17" x 22")

Saf-T-Seal® Cast & Bandage Protector

- Unique patented ring eliminates need for strapping or hook and loop closure
- Latex free diaphragm, stretches easily over cast to form watertight seal
- Durable polyvinyl protector prevents water penetration.

LATEX FREE!



Hand, Arm, Foot and Leg

Adult

- #6010 Foot/Ankle (10")
- #6011 Hand (11")
- #6012 Short Arm (22")
- #6013 Long Arm (39")
- #6014 Short Leg (23")
- #6015 Long Leg (42")

Pediatric

- #6020 Medium Arm (18")
- #6021 Large Arm (22")
- #6022 Medium Leg (18")
- #6023 Large Leg (23")



Extra Wide Opening
 #6012W Short Arm (22")
 #6014W Short Leg (23")

Saf-T-Seal®
 Hand, Arm, Foot and Leg Cast and Bandage Protector

Bathe or Shower with Confidence and Comfort

- Unique ring eliminates need for vinyl bags with strapping or hook and loop closure
- Latex free diaphragm, stretches easily over cast to form watertight seal
- Durable polyvinyl protector prevents water penetration.

NOTE: Use caution when in wet, slippery conditions. Check for sharp surfaces on plaster casts. Always grip plastic ring to remove. Made in Taiwan

Attractively Boxed



Portable Bidet & Washmate **NEW!**

- Gentle form of personal hygiene
- Convenient size
- Simple to use
- 9" curved nozzle for longer reach
- Attractive retail box

#3142 Portable Bidet & Washmate

#3147 **NEW!**

Works with Toilet Paper and Pre-Moistened Wipes

Long Range Comfort Wipe

- Easy to use for personal hygiene
- Flexible hand grips toilet paper or pre-moistened wipes
- Release button for easy disposal
- Sturdy ABS plastic - 15" long

#3147 Long Range Comfort Wipe
#3147K Long Range Comfort Wipe plus cover

Cast and Bandage Protector



- Heavy duty PVC heat sealed seams
- Adjustable latex straps for closure
- Easy to use without assistance

- #6030** Foot/Ankle - Adult (one size fits most) 10" x 17-1/4"
- #6031** Half Arm Adult/Full Arm Child 8" x 29"
- #6032** Full Arm Adult 10" x 29"
- #6034** Half Leg Adult/Full Leg Child 13" x 41"
- #6035/6036** Medium/Large Leg - Full Leg Adult 15" x 41"



Wipe Aide Toilet Paper Moistener

Safe for any plumbing system

NEW!

- Moistens toilet paper for gentle cleaning
- Refillable for continuous use
- Easy to use
- Keeps you fresh and clean
- Dispenses gentle cleaning action
- Holds 28 fl. oz.

#5013 Wipe Aide Toilet Paper Moistener



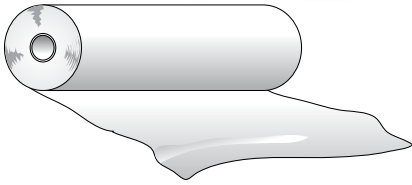

Rubber/Flannel Waterproof Sheeting

- Comfortable cotton flannel bonded to rubber
- Autoclavable and waterproof
- Provides longlasting comfort and protection

- #5100 Rubber Flannel Sheeting - 36" x 36"
- #5102 Rubber Flannel Sheeting - 36" x 54"
- #5104 Rubber Flannel Sheeting - 36" x 72"
- #5106 Rubber Flannel Sheeting - 36" - 12 yd. roll

Water Proof Draw Sheet



- Total comfort and absorbency
 - Super absorbent pad (34" x 36") with tuck-tails to hold pad in place
 - Fits full size beds with 20" tails on each side
 - Machine wash and dry
 - Three layer pad with polyester soaker and water proof bottom
- #5003 Water Proof Draw Sheet**

Contour Fitted Sheets For Hospital Beds

- Designed specifically for the hospital bed
- Provides greater comfort and ease of patient handling
- Aids in prevention of bed sores
- Completely washable. Measures 36" x 80"
- White, 50% cotton, 50% polyester

- #5020 Contour Fitted Sheet, white, 36" x 80"
- #5021 Contour Fitted Sheet dozen per pack

Hospital Bedding Sheet Sets

- Fitted sheet, top sheet and pillow protector
 - 50% cotton/50% polyester
 - 132 thread count
 - Machine washable - white
 - Size: 36" x 80" x 6"
- #5037**



#5020



Ultra-Dry Fitted Waterproof Mattress Pads



100% Waterproof Protection

- Ultra soft fleece top fabric with waterproof vinyl backing
- 15" elastic all around band - easy to put on and not shift or slip off.
- Plush inner layer of Fiber Fill
- Easy care machine wash and dry

- #5071 Twin Size (36" x 75")
- #5072 Full Size (53" x 75")
- #5073 Queen Size (60" x 80")
- #5074 King Size (78" x 80")



#5000

Protective Chair Bed Pad

- Quilted plaid seat pad
- Top layer soft brushed polyester
- Unique moisture barrier in center for improved absorption
- Bottom layer totally waterproof
- Completely washable

- #5000 Protective Pad 18" x 24" Plaid
- #5002 Protective Pad 34" x 36" Plaid



#5004

Economy Waterproof Pads

- Soft and absorbent
- Breathable, comfortable and quiet
- Prevents leakage and eliminates staining
- Polyester bonded to vinyl
- Completely washable

- #5004 Waterproof Pad 36" x 36"
- #5006 Waterproof Pad 36" x 72"



#5001

Comfort Dry Mattress Pad

- Highly absorbent plush polyester on each side
- Center waterproof vinyl barrier for total protection
- Polyester laminated to vinyl pad
- Stays quiet and comfortable
- Pad corners stitched for extra durability
- Machine washable - White

- #5001 Comfort & Dry Mattress Pad 24" x 36"



#5010

Deluxe Quilted Underpad

- Comfort and protection
- Flannel quilted top, highly absorbent soaker barrier in center
- Bottom layer totally waterproof
- Completely washable

- #5010-30 Quilted Underpad 30" x 36"
- #5010-36 Quilted Underpad 34" x 36"
- #5010-54 Quilted Underpad 34" x 54"
- #5010-54H Quilted Underpad 34" x 54" with turn handles
- #5010XL Quilted Underpad 36" x 80" with straps



Contoured/Zippered Mattress Protectors 36" x 80" For Hospital Beds

- Heavy duty white PVC
- Reduces odor and improves sanitation
- Extends life of the mattress
- Size 36" x 80"
- Waterproof and fire retardant

Zippered Mattress Covers Protects against bed bugs, dust mites, and allergens



- Waterproof and fire retardant
- Antimicrobial treated to inhibit growth of mold, mildew and odor causing bacteria
- High density polypropylene
- Rust proof polyester zipper

- #5022 Contour Protector 1 Unit
- #5023 Zippered Protector 1 Unit
- #5024 Contour dozen per pack
- #5026 Zippered dozen per pack
- #5005 Standard zippered pillow case
- #5007 Hospital bed (36" x 80")
- #5008 Twin zippered (39" x 75")
- #5009 Full zippered (54" x 75")

Mattress Covers for Home Beds

- Waterproof heavy duty vinyl
- Taffeta finish, fire retardant
- Electronically sealed seams
- Anti-microbial treated
- Wipes clean with damp cloth



- #5027 Twin Contour 39" x 75"
- #5028 Twin Zippered 39" x 75"
- #5029 Full Contour 54" x 75"
- #5030 Full Zippered 54" x 75"
- #5031 Queen Contour 60" x 80"
- #5032 Queen Zippered 60" x 80"
- #5033 King Contour 78" x 80"
- #5034 King Zippered 78" x 80"

Pillow Protectors

- Waterproof and hypo-allergenic
- Plasticized vinyl
- Rust resistant zipper

- #5035 Vinyl Pillow Protector (21" x 27")



Cotton Bed-In-A-Bag For Home Hospital Beds

- Contains one (1) each:
- Jersey knit cotton fitted sheet
 - Jersey knit cotton top sheet
 - Jersey knit cotton pillow case
 - 100% Cotton thermal blanket
- #5036 Cotton Bed-In-A-Bag



Adjustable Hernia Support

- Supports single or double hernias
- Lightweight, invisible under clothes
- Complete with two removable pads
- Sizes: S (30"-33"), M (34"-37"), M/L (38"-41"), L (42"-45"), XL (46"-49")

- #2078 Adjustable Hernia Support



Super Kegel Exerciser - Pink

- Helps tone and strengthen pelvic muscles to aid in bladder control
- Helps tighten pelvic floor muscles
- Helps alleviate leakage due to incontinence
- Instructions and exercise routine included
- Poly Propopylene coated steel (9" L x 7-1/8" W x 4" H)
- Adjustable tension settings.

- #5068 Super Kegel Exerciser



Safety Undergarment Leg Bag System - Designed for ambulatory and wheelchair users

- Comfort and privacy - incontinence protection with dignity
- Eliminates constriction of circulation to lower leg
- Does not cause painful skin ulcers
- Keeps leg bag securely on leg without leg straps
- Designed for UI, nephrostomy, foley catheters, etc.

- System consists of cotton undergarment with two pockets (washable), rubber leg bag (24 oz) with T-valve release port, tubing with connector

- Sizes - S - 28"-30"; M - 32"-34"; Lg - 36"-38"; XL - 40"-42"

- #5063 Safety Undergarment

- #5064S Safety Undergarment + Leg Bag System

- #5064B Replacement Rubber Leg Bag

Medicare reimbursement, one per month

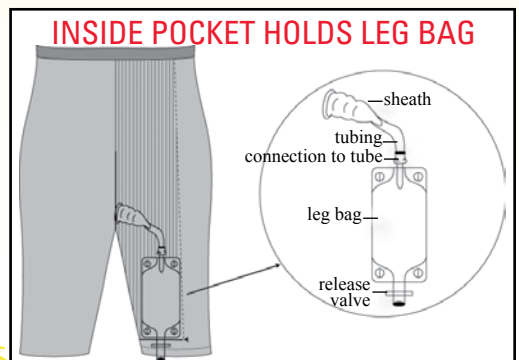

HCPCS A5112





Lady Rose Lace Absorbent Panty with built-in liner

HCPCS T4539

- Reusable, washable premium lace panty
- Stretchy elastic waistband
- Attractive lace design
- Available in sizes Small, Medium, Large, XL, XXL

Built-in Pad Provides Complete Protection:

- Fast-absorbing top layer quickly wicks moisture away from body
- Soaker core absorbs & traps fluid
- Waterproof barrier protects against leakage

#5060 Lady Rose Lace Absorbent Panty

Sizes for #5060 and #5062

Women's	Small	Med.	Large	XL	XXL
Fits Hip Size	35-38	39-40	41-42	43-45	46-49



#5065

Waterproof Plasticized Pull-on Incontinent Pant

- Machine washable - plasticized polyester
- Waist and leg bands are elasticized for comfort and protection
- Can be used by men, women and children
- Perfect for use with pads, diapers and other absorbent materials

#5065 Waterproof Plasticized Incontinent Pant

XS 14"-20"
S 22"-28"
M 30"-36"

LG 38"-44"
XL 46"-52"
XXL 52"-56"



HCPCS T4539

#5062

Absorbent Lady Rose Cotton Panty with built-in liner

- Reusable, washable premium cotton panty
- Stretchy elastic waistband
- Attractive 100% cotton "Diamond Weave" fabric
- Available in sizes Small, Medium, Large, XL, XXL

Built-in Pad Provides Complete Protection:

- Fast-absorbing top layer quickly wicks moisture away from body
- Soaker core absorbs & traps fluid
- Waterproof barrier protects against leakage

#5062 Absorbent Lady Rose Cotton Panty



NEW!

Waterproof Vinyl Pants

- Pull-on style, great protection over incontinent briefs or liners
- Soft, quiet vinyl, elastic at waist and legs
- Completely washable - machine wash & dry
- Latex Free, Pack of 3

#5075 Waterproof Vinyl Pants

M 30"-36"
LG 38"-44"

XL 46"-52"
XXL 52"-56"

Deluxe Disposable Mattress Pads

- Dry to the touch
- Poly backing to prevent leaks
- Protects bedding and chairs
- Hyper allergenic - Latex-free
- Linen fresh scent for odor control

#5055 Deluxe Disposable Mattress Pads

21"x23", 100 Pads Per Case, (50 per poly bag)



Hydrex™ Pad

Moisture-wicking Hydrex™ pad keeps you dry

Mens Incontinence Brief

Comfort - Dignity - Durability

- Washable & Reusable
- Vertical fly & waistband stripe
- Thin highly absorbent pad enclosed in soft cotton-blend panel - protects front and midway up the back
- Pad keeps moisture away from skin
- Sm. (30"-32"), Med. (34"-36"), Lg. (38"-40")
XL (42"-44"), 2X (46"-48"), 3X (50"-52")

#5070 Mens Incontinence Brief



Moisture-wicking Hydrex™ pad keeps you dry

NEW!

Men's Incontinence Boxer Shorts

- Built-in unique super absorbant pad
- Washable and reusable cotton/poly jersey
- Button fly front
- Material treated to eliminate bacteria
- Sizes: S (30"-32"), M (34"-36"), L (38"-40"), XL (42"-44")

#5076 Men's Incontinence Boxer Shorts



HOME CARE PACK

Fashionable and Comfortable Gowns

Convalescent Comfort Gowns

- One size fits all
- Easy fit-two tape ties or hook and loop
- Machine washable-polyester/cotton
- Available in attractive retail pack or bulk pack by the dozen

- #5040 Blue Retail Pack
- #5041 Blue Pack (12 Per Poly Bag)
- #5042 Yellow Retail Pack
- #5043 Yellow Pack (12 Per Poly Bag)
- #5044 Blue Print Retail Pack
- #5045 Blue Print Pack (12 Per Poly Bag)
- #5046 Mint Green Flannel Retail Pack
- #5047 Mint Green Flannel Pack (12 Per Poly Bag)
- #5048 White With Blue Print Retail Pack
- #5049 White With Blue Print (12 Per Poly Bag)
- #5050 Blue w/velcro closure Retail Pack
- #5051 Blue (5040 w/velcro closure) (12 Per Poly Bag)



#5042

#5040

#5048

#5044

NEW COLOR

#5046 & #5047
(Flannel)

IV Patient Gowns

NEW!

- Easy on/off snaps on shoulder
- Machine washable-polyester/cotton
- One size fits all
- Attractive print pattern

#5052 IV Patient Gown



NEW!



Men's Plaid Nightshirt

- Comfortable and functional
- One size fits all
- Hook & loop back closure

NEW!

- Dacron/Cotton, completely washable
- #5056 Men's Plaid Nightshirt**

Dignity Convalescent Gown

- Unique design attaches at the shoulder by snaps. Gown goes on over the head, poncho style.
- Ties on back panel come around and tie in front - covering the back.
- Completely washable - 55% cotton, 45% polyester.
- One size fits all.

#5053 Dignity Convalescent Gown



NEW!

#3001 Knee & Elbow Warmers (Pr.)

Knee & Elbow Warmers

- 100% acrylic stretch material
- Machine washable
- Ivory color
- One size fits all

Non-Slip Wheelchair Blanket

- Lightweight, soft, cozy, comfy feel
- Two hook and loop tabs keep it securely attached
- Two hand warmer pockets & one middle pocket
- Tapers at bottom to avoid getting caught in wheels
- 95% polyester, 3% pp, 2% nylon
- 41" x 30" x 19.69" (tapered)

NEW!

#5054 Wheelchair Blanket (Burgundy)



ALL NEW!

Compression Foot Sleeves



- Relieves plantar fasciitis
- Eases heel pain
- Aids in recovery
- Soft, moisture wicking fabric

- Comfort fit for all day or night wear
- 24% lycra spandex, 76% micro-nylon
- Sizes (pair)
- Medium - Women's 7-10/Men's 6-9-1/2
- Large - Women's 11+, Men's 10-13

NEW!

#7145 Compression Foot Sleeves



6 Compression Zones



#7114

RELIEF FOR PLANTAR FASCIITIS, HEEL SPURS & ACHILLES TENDONITIS

HCPCS L4396

Passive Night Splint

- Splint adjust easily and holds foot and toes in a position - pair of gel heel cushions included
- Stretches plantar fascia and the achilles tendon
- Soft padded velour is washable
- Fits right or left foot men's 6-12 women's 4-13

#7114 Passive Night Splint-One Size Fits All



Gel Heel Pads for Plantar Fasciitis & Heel Alignment

NEW!

- Made of 100% polymer gel with absorbing, cushioning ability
- Fits most any shoe size
- Available in men's (7-13) shoe size and women's (5-11) shoe size

#7113M Gel Heel Pads (Men's Pr.)
#7113W Gel Heel Pads (Women's Pr.)



Patented fasciitis bar provides midfoot support

Heel Saver

Indications-Plantar Fasciitis, Heel Spurs and Arch Pain

- Made from durable Kraton material for long-time use
- Washable
- Applies accurate acupressure as weight shifts
- Does not interfere with the fit of the shoe
- Use with any type of shoe with a backing
- Stays in place

#7124Std Heel Saver, Standard (Pr.) (Women's Size: 7-10, Men's Size: 5-8)
#7124Lg Heel Saver, Large (Pr.) (Women's Size: 10 & Up, Men's Size: 9-12)



Provides natural structural reinforcement to prevent partial collapse of the midfoot



Redistributes the heel's natural fat pad, actually increasing its density



Applies continuous localized, acupressure directly beneath the heel pain hot-spot

RELIEVE All Forms of Heel Pain REVERSE Progressing Conditions
PREVENT Future Recurrences
Medically Proven 99.7% Success Rate



ADJUSTABLE HOOK & LOOP CLOSURES STRAPS

#7112

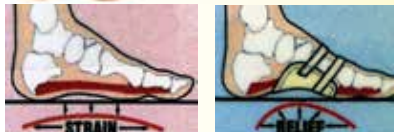

Arch Brace for Plantar Fasciitis

- Immediate pain relief
- Relieves inflammation and heel pain
- Two adjustable straps attach easily
- Can be worn against skin or over hosiery

#7112-A Arch Brace (Men's 7-8 1/2, Women's 6-10 1/2)
#7112-B Arch Brace (Men's 9-13)



Foot Rocker

NEW!

- Minimize heel, leg and back discomfort
- Optimum foot position for proper stretching
- Helps work leg muscles and prevent foot injuries
- Perfect stretch exercise
- Solid ABS plastic and rubber
- Safe grip treads

#7117 Foot Rocker



Plantar Fasciitis Night Splint

- Helps relieve heel pain and Achilles Tendonitis as well
- Worn at night to stretch Plantar Fascia and Achilles
- Stretch helps reduce inflammation, pain and tenderness
- Latex free, easy to use velcro straps

#7110 Night Splint / One Size Fits All

NEW!

NEW!



CRADLES THE BUNION IN TOTAL COMFORT

Bunion Gel Toe Pad

- Orthotic sleeve with sewn-in gel pad supports cushions and protects painful bunions
- One size fits most - right or left
- Nylon, spandex, silicone

#7144 Bunion Gel Toe Pad



PneuGel® Ankle Support or Economy Ankle Support

HCPCS L4350

- #8114 Allows patient to inflate or deflate the bladder to provide maximum comfort, support and protection
- #8114 lower chambers contain gel, allowing the support to be used in cold therapy applications
- #8113 utilizes pre-sealed air filled bladders and provides excellent support and protection
- #8114 bladders are removable and can be placed in the freezer allowing them to be used as cold therapy devices

#8113 Economy Strirup Ankle Support (one size fits all)

#8114 PneuGel® Ankle Support (one size fits all) (Pump Included)

NEW!



Bunion Regulator

- Night time appliance
- Molded splint cradles and repositions big toe
- Stretches tendons and muscles
- Washable - one size fits all
- Indicate right or left foot

#7140R Bunion Regulator
#7140L Bunion Regulator
#7140R Bunion Regulator Right



MOLDED TO ORTHOPEDIC FORM

Crest Buttress Pads

- Pad catches minor problems early and helps claw and hammer toes maintain a more normal position
- Relieves pressure and friction which causes corns and soreness
- Lightweight, washable foam pad

#7120SR Small Right **#7121ML Medium Left**
#7120SL Small Left **#7121LR Large Right**
#7121MR Medium Right **#7121LL Large Left**



DOUBLE #7127

Toe Regulators

- Ideal for surgical procedures for hammer toes or metatarsals
- Totally adjustable toe loop
- Provides immediate comfort
- Completely washable



SINGLE #7126

#7126 Single Loop
#7126DZ Single Loop Dz. Pack
#7127 Double Loop
#7127DZ Double Loop - Dz. Pack
#7128R Triple Loop, Right
#7128L Triple Loop, Left



#7119

Calcaneal Heel Cups

- Ideal for high heels and Plantar heel spur
- Eliminates gapping and slipping of shoes
- Unbreakable plastic

#7119 Junior - (6 pr/pkg)
#7119 Standard - (6 pr/pkg)

HCPCS L3260



#6004

Deluxe Post-op Shoe

- Hook and loop straps
- Padded heel collar for comfort
- Blue nylon mesh
- Skid resistant bottom
- Women's S, M, L
- Men's M, L, XL

#6004 Deluxe Post-op Shoe

SIZING CHART
#6004 DELUXE POST-OP SHOE

Size	Women's Shoe Size	Men's Shoe Size
Small	4-6	6-8
Medium	6.5-8.5	8.5-10
Large	8.5-10	10.5-12
X-Large		12.5-14

SIZING CHART
#6000 ROCKER BOTTOM CAST SHOE

Size	Women's Shoe Size	Men's Shoe Size
Small	5.5-7.5	
Medium	8-10	6-8.5
Large		9-11.5
X-Large		12-14



#6000

Rocker Bottom Cast Shoe

- Aids in patient mobility
- Open toe and heel for comfort
- Hook and loop closure for better fit
- Non-slip design
- Attractive blue duck fabric
- S, M, L, XL

#6000 Rocker Bottom Cast Shoe



#4031-4

4" Foot Elevator

- Ideal for the prevention and treatment of decubitus ulcers
- Hook and loop closure
- Flannel cover
- One size fits all

#4031-4 4" Foot Elevator



#7148 Gel Heel Socks (pair)

Gel Heel Socks "Revitalize and Heal"

- Soften and help heal dry, cracked skin
- Built-in gel pad contains vitamin E, jojoba oil, lavender oil and olive oil
- Hand washable - lightweight nylon
- One size fits all, nylon



Chrome Plated Nail Nippers

- Coil spring and and concave cutting edges

#3166 Chrome Plated Nail Nippers



Easy Empty Nail Clip Catcher
Wide, Non-Slip Comfort Grips
Wide Opening for Thick, Hard Nails

Lighted Magnifying Nail Clipper

- Easy to use 3X magnifier
- Bright LED light easy to see
- ABS plastic stainless steel clipper
- 3 button cell batteries included
- Attractive display card

#3104 Lighted Magnifying Nail Clipper
#3104DP 6 Unit Counter Display



IDEAL FOR THOSE WITH ARTHRITIS OR LIMITED HAND STRENGTH

Easy Cut Toe Nail Nippers

- Surgical steel blades
- Stay sharp
- No-slip soft handle
- 5-1/2" long spring design - easy to use

#7160 Easy Cut Toe Nail Nippers



PLEASE SPECIFY STANDARD OR LARGE



#7116

Toe Caps

- Long lasting, washable silicone-based hydrogel toecaps
- Effective for use on H.D. and H.M. lesions
- Ideal treatment for corns on the toe tip or hammer toe
- Available in standard and large (big toe)

#7116 Toe Caps (2 per package)

Finger and Toe Protective Bandage

- Soft breathable foam-lined with seamless tubular cotton fabric
- Relieves irritation due to friction bruises and pressure
- 3 rolls package – 36" per roll

Sizes: #3054 5/8" O.D.
#3055 3/4" O.D.
#3056 1" O.D.
#3057 1- 36" one each of 5/8", 1/4" and 1"



#3054

3 ROLLS PER PACKAGE



#7115

Comfort Gel Heel Cushions

- Soft, breathable fabric cover on one side, shock-absorbing gel on the other side
- Tapered edge for better fit
- Available Men's (7-13) shoe size and women's (5-11) shoe size

#7115M Comfort Gel Heel Cushions (Men's Pr.)
#7115W Comfort Gel Heel Cushions (Women's Pr.)



Foot Cleaning Brush

- 25" long, soft nylon bristles
- Comes with two sponge heads

#3039 Foot Cleaning Brush
#3039SP 3 replacement sponges





Diabetic Slipper Socks with Gripper Soles

- Comfort, Protection and Non-Slip Design
- Use as Slipper or Footwear
- Helps Reduce Pressure on Sensitive Legs

#7134 Ladies Size 9-11

#7135 Men's Size 10-13

#7135XL Size 14-17 (Black or White only)

Colors - White, Tan, Black
(Made in USA)



New . . . Skin Cream created specifically to meet the exacting demands of diabetic skin care by a diabetic physician

- Helps reduce the risk of foot complications due to diabetes
- Contains antioxidants and vitamins A, D, E, Provitamin B5 for healthy skin and nerves
- Moisturizes and softens feet and reduces painful cracking and dryness

US PATENT
#6541447

#7170 Diabetic Foot Cream (5 oz. tube)

#7170DP (Display plus 6 units)

#7171 Diabetic Hand and Body Cream (5 oz. tube) **NEW!**

#7171DP (Display plus 6 units)



Diabetic Cushioned Socks

- Cushioned terry soles
- Non-binding tops
- Non-irritating flat toe seams
- Cotton/poly/nylon/lycra
- Made in USA

#7152W - Women's sizes 9-11

#7152M - Men's sizes 10-13



Multi-Purpose Diabetic Socks

- Ideal for Diabetic, Poor Circulation or Sensitive Feet
- Extra Wide, Non-Binding Top
- Stays in Place Plus Support for Calf Muscles
- Unique Blend 85% Cotton, 13% Poly, 2% Elastic
- Soft, Breathable and Washable
- Colors: White or Black
- 2 pair per package

MADE IN USA

#7136 Black - Small (Size 6-8), Medium (Size 9-11), Large (Size 10-13), X Large (Size 14-17)

#7137 White - Small (Size 6-8), Medium (Size 9-11), Large (Size 10-13), X Large (Size 14-17)

Diabetic Sock with Gel Heel

Maximum Comfort:

- Pressure Free Socks
- Improves Circulation
- Cool Breathable, 80% Cotton, 20% Nylon, Silicone

Unique Gel Heel For:

- Support
- Cushioning
- Comfort
- Keeps Heels from Drying Out
- Helps Prevent Friction & Callus Formation



#7133W (Ladies Size 6-9)

#7133M (Men's Size 9-12)

Arthritic/Diabetic Gel Socks

- Soft and lightweight sock combined with proprietary gel insole that cushions, supports, and helps absorb shock to the entire plantar (bottom) surface of the foot, heels, ankles, knees, and back.
- Product is designed to conform to the anatomical shape of the user's foot.
- Will not flatten under repeated pressure.
- Helps reduce friction, abrasion, shear forces, and callus formation
- Serves as a soft tissue supplement to fat pad atrophy

MADE IN USA

SPECIFY SIZE

- Small Shoe size 6 or under #7150S
- Med. Shoe size 9 or under #7150M
- Lg. Shoe size 9 or over #7150L

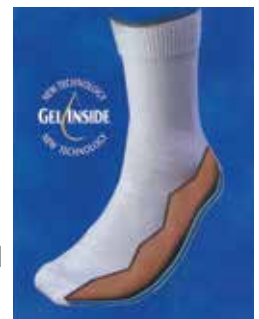



Full Face Mask

HCPCS
A7030

- Lightweight Contoured Silicone Design
- 360° Dual Swivel Elbow Port:
- Ergonomic, Flexible Design
- Headgear with Quick Release Clips
- Air Vent Holes and One Way Valve Design
- Available in 3 Sizes

#9102 Full Face Mask

#9103 Full Face Replacement Seals,
Small-Medium-Large



Nasal Mask

HCPCS
A7030

- Single-Piece Silicone Design
 - 360° Dual Swivel Elbow Port
 - Ergonomic Design
 - Headgear with Quick Release Clips
 - Comfortable and Adjustable Forehead Support
- Two Sizes to Cover Different Ranges in Patient Size: Medium, Large.**

#9104 Nasal Mask



Sleep Apnea CPAP Pillow

Quality polyester filling

- Unique patented design helps hose stay in position preventing air from leaking out.
- Promotes natural breathing rhythm
- Anti-microbial and hypo-allergenic

#9112 Sleep Apnea CPAP Pillow

#9112C Cover for Sleep Apnea CPAP Pillow



Sleep-Ease Apnea Memory Pillow

- Total Comfort and Compliance for C-Pap and Bi-Pap Users.
- Unique Ergonomic Design Allows Shoulders, Neck and Head Support
- Contact Free Mask Use Sleeping on Back or Side.
- Washable White Plush Terry Poly/Cotton Cover
- 21" L x 15-1/2" W x 4" H

#9106 Memory Pillow & Cover

#9107 Replacement Cover



CPAP Hose Holder

Sleep easy-without discomfort

- Adjustable sliding arm
- Slides between mattress & box spring
- Sturdy metal construction
- No assembly required
- Compactly folds for storage & portability
- Includes free storage pouch
- 34.5" tall

#9108 CPAP Hose Holder



Breathe Easy Mask

Washable and Antimicrobial

- Filters airborne germs, dust, pollen, bacteria, mold spores, etc.
- Permanently treated with microbe shield
- Helps wick away moisture
- Adjustable ear hooks and flexible nose form for custom fit
- One size fits all - Made in USA
- Available in blue or beige

#9118 Breathe Easy Mask



C-PAP Chin Strap

- Cradles jaw to help keep your jaw closed
- Stretch neoprene strap
- Adjustable and lined for comfort
- Works with all C-PAP Masks
- Max circumference 32-1/2"
- Helps prevent nasal and oral drying

#9115 C-PAP Chin Strap



CPAP Comfort Pads

- Keeps CPAP mask away from skin
- Helps prevent irritation and red marks
- Wrap around plush straps attach securely with hook and loop fasteners
- 100% polyester pads measure 6" L x 1-1/4" W
- Machine washable and reusable

#9110 CPAP Comfort Pads (Set of 2)

ProKit™ Combo Aneroid Sphygmomanometer and Aluminum Dual Head Stethoscope with Attaché Case

Includes:

- Coordinating adult calibrated nylon cuff with 2-tube bladder
- Standard air release valve and inflation bulb
- Aluminum dual head stethoscope
- One spare set of eartips

Colors Available: 01-Black, 02-Navy, 03-Royal Blue, 04-Burgundy, 06 Green, 08-Magenta, 11-Purple

#02-127 ProKit™ Combo



Self-Taking Home Blood Pressure Kit

- Aneroid gauge with large dial, easy-squeeze inflation bulb and attached professional stethoscope
- Soft cotton D-ring-cuff allows for easy application
- Adult size cuff fits arm circumference: 10"-14"
- Latex-free

Includes

Gauge, inflation bulb, attached stethoscope, adult arm cotton cuff, zippered attache case, detailed English/Spanish guidebook and blood pressure reading log

#01-5501 - Self-Taking Home Blood Pressure Kit



Aluminum Dual Head Stethoscope

- Lightweight anodized aluminum chestpiece with non-chill diaphragm retaining ring and vinyl Y-tubing, latex free.
- Complete with spare diaphragm, mushroom eartips and Lifetime Limited Warranty

#05-121 Aluminum Dual Head Stethoscope (Boxed)



Colors Available:
01-Black, 02-Navy,
03-Royal Blue,
04-Burgundy,
06 Green,
08-Magenta,
11-Purple

Sprague-Rappaport-Type Stethoscopes

- Superior acoustics
- Zinc-alloy chest piece
- Double vinyl tubing
- Five interchangeable chest pieces
- Full color retail pack
- Attractive accessory pouch

#05-111

**Sprague-Rappaport-Type
Stethoscope (Boxed)**



Colors Available:
01-Black, 02-Navy, 03-Royal Blue,
04-Burgundy, 06-Green, 11-Purple

Replacement Cuff Automatic Blood Pressure Arm Monitor

- Replacement cuff for automatic blood pressure arm monitors
- Latex-free

#01-5921 - Replacement Cuff (Adult-11-3/4" - 16-1/2")

#01-5922 - Replacement Cuff (Large Adult - 16-1/2" - 18-7/8")

#01-5926 - Replacement Cuff (Small Adult - 8-5/8" - 11-3/4")



Clinical Accuracy

- Quick
- Accurate
- Easy to Use

Economy Wrist Blood Pressure & Pulse Monitor

- Slip on wrist and press button
- Stores up to 60 readings
- Plastic carrying case
- Requires 2 AAA batteries (not included)

#9100 Wrist Blood Pressure
& Pulse Monitor

Automatic Digital Blood Pressure Wrist Monitor EASY HOME MONITORING ONE-BUTTON OPERATION CLINICALLY ACCURATE READINGS



- Clinically accurate readings
- One-button blood pressure measurements
- Fully automatic inflation and deflation
- Simultaneous systolic, diastolic and pulse results
- 60-reading memory bank
- Memory recall with date/time stamp
- Average of last 3 readings
- Hypertension indicator
- Irregular heartbeat detection
- Automatic shut-off
- Latex-free cuff fits wrist size: 5-1/2" - 7-5/8"
- Canvas storage case
- Batteries; 2 AAA

#01-506 - Automatic Digital Blood Pressure Wrist Monitor
Also Available

#01-516 - Jumbo Screen Premium Blood Pressure Wrist Monitor

Semi-Automatic Digital Blood Pressure Arm Monitor



**EFFICIENT HOME MONITORING
MANUAL INFLATION, AUTOMATIC DEFLATION
CLINICALLY ACCURATE PERFORMANCE**

- Clinically accurate readings
- Manual inflation and automatic deflation
- Easy-squeeze bulb
- Simultaneous systolic, diastolic and pulse results
- 60-reading memory bank
- Memory recall with date/time stamp
- Hypertension indicator
- Irregular heartbeat detection
- Automatic shut-off
- Latex-free adult cuff fits arm size: 11-3/4" - 16-1/2"
- AC adapter port
- Canvas storage case
- Batteries included; 4AA

Complete Monitoring System

Monitor, adult nylon arm cuff with inflation bulb, canvas storage case, four AA batteries, detailed English/Spanish guidebook, quick start guide, FAQ pamphlet and blood pressure charging log.

**#01-5041 - Semi-Automatic Digital Blood Pressure Arm Monitor
Mabis Model #04-391-001 (Cuff 11-3/4" x 16-1/2")**

**#01-5042 - Semi-Automatic Digital Blood Pressure Arm Monitor
with Extra Large Cuff (16-1/2" x 18-7/8")**

Automatic Digital Blood Pressure Arm Monitor



**EASY HOME MONITORING
ONE-BUTTON OPERATION
FULLY AUTOMATIC INFLATION/DEFLATION**

- Clinically accurate readings
- One-button blood pressure measurements
- Fully automatic inflation and deflation
- Simultaneous systolic, diastolic and pulse results
- 60-reading memory bank
- Memory recall with date/time stamp
- Hypertension indicator
- Irregular heartbeat detection
- Automatic shut-off
- Latex-free adult cuff fits arm size: 11-3/4" - 16-1/2"
- AC adapter port
- Canvas storage case
- Batteries included; 4AA

Complete Monitoring System

Monitor, adult nylon arm cuff, canvas storage case, four AA batteries, detailed English/Spanish guidebook, quick start guide, FAQ pamphlet and blood pressure charging log.

**#01-5021 - Automatic Digital Blood Pressure Arm Monitor
Mabis Model #04-591-001**

**#01-5022 - Automatic Digital Blood Pressure Arm Monitor
with Extra Large Cuff**



SMARTHEART™

Automatic Digital Blood Pressure Wrist Monitor

**EASY HOME MONITORING
ONE-BUTTON OPERATION
CLINICALLY ACCURATE READINGS**

- One-button blood pressure measurements
- Large LCD Display
- Fully automatic inflation and deflation
- Simultaneous systolic, diastolic and pulse results
- 1-person memory bank holds 60 readings
- Memory recall with date/time stamp
- Hypertension indicator
- Irregular heartbeat detection
- Automatic shut-off
- Latex-free cuff fits wrist size: 5-1/2" - 7-5/8"
- Storage pouch
- Batteries included: 2 AAA



#01-556 - Automatic Digital Blood Pressure Wrist Monitor

SMARTHEART™

Automatic Digital Blood Pressure Arm Monitor

**EASY HOME MONITORING
ONE-BUTTON OPERATION
CLINICALLY ACCURATE READINGS**

- One-button blood pressure measurements
- Large LCD Display
- Fully automatic inflation and deflation
- Simultaneous systolic, diastolic and pulse results
- 1-person memory bank holds 60 readings
- Memory recall with date/time stamp
- Hypertension indicator
- Irregular heartbeat detection
- Automatic shut-off
- Latex-free adult cuff fits arm size: 8-3/4" - 12-1/2"
- Storage pouch
- Batteries included: 4 AA



#01-550- Automatic Digital Blood Pressure Arm Monitor



Talking Thermometers - Includes 3 Frogs, 3 Dogs and 2 Monkeys!

- 20-second readout
- Peak temperature tone
- Memory recall of last reading
- Fever alert plays corresponding animal sound for each thermometer, "Ribbit, Ribbit, Ribbit" for the Frog, "Ooooh Oohh, Aaaah Aaahhh" for the Monkey, and "Ruff, Ruff, Ruff" for the Dog
- Fahrenheit/Celsius measurements

- Soft flexible comfort tip
- Oral, rectal or underarm use
- Automatic shut-off
- Low battery indicator
- Meets ASTM Standard E-1112
- Latex-free, BPA-free

Complete Monitoring System

Thermometer, half storage case, 5 probe covers, 2 long-lasting LR41 batteries and detailed English/Spanish instructions.



#08-3758D (Display plus 8 units)



Complete Monitoring System

Thermometer, full storage case, replaceable LR41 battery and detailed instructions.

#08-302VC (Display plus 9 units)



9-Piece Digital Thermometer Display

- 60-second readout
- Proven clinical accuracy
- One button operation
- Memory recall of last reading
- Fahrenheit/Celsius measurements
- Clinical tip
- Oral, rectal or underarm use

- Water-resistant for cleaning
- Automatic shut-off
- Full storage case
- Meets ASTM Standard E 1112
- Latex-free, BPA-free
- Battery included: LR41

Temple Touch Mini Digital Thermometer

- For infants and children
- Proven clinically accurate
- One-button operation
- Memory recall of last reading
- Fahrenheit/Celsius measurements
- Automatic shut-off
- No probe covers required
- Meets ASTM Standard E 1112
- Latex-free
- Batteries included: 2AAA

6 SECOND READOUT



#09-330
3 per case

Instant Digital Ear Thermometer

- Proven clinically accurate
- One-second tympanic readout
- Backlit, illuminated LCD display
- Peak temperature tone
- Memory recall of last 10 readings
- Fever alert for temperatures above 99.5°F
- Fahrenheit/Celsius measurements
- Automatic shut-off
- No top covers required
- 2-piece full storage case
- Low-battery indicator
- Battery included: 3 volt lithium battery CR2032
- Detailed English/Spanish instructions.



#09-340
One per case



Deluxe Fingertip Pulse Oximeter

- Safely monitor oxygen levels and pulse rate
- One button operation
- Automatic shut-off
- Batteries included (2AAA)
- Two year limited warranty

Adjustable neck strap and storage case

#9101 Deluxe Fingertip Pulse Oximeter



HCPCS
E0445

SmartHeart Fingertip Pulse Oximeter

SAFELY MONITOR OXYGEN LEVELS AND PULSE RATE

- Portable spot-check monitoring, accurate measurements
- One-button operation, easy application
- Comfortable fingertip grip, latex free
- Automatic shut-off
- Batteries and lanyard included

HCPCS
E0445



#11-50K SmartHeart
Pulse Oximeter





#11-505 - VH Compact Tabletop Compressor Nebulizer

VH Compact™ Tabletop Compressor Nebulizer System

LIGHTWEIGHT, COMPACT DESIGN
FAST AND EFFECTIVE MEDICATION DELIVERY - EASY, ONE-BUTTON OPERATION

- Lightweight compact design
- Piston-style compressor pump
- Treatments delivered in 8-10 minutes
- Built-in nebulizer holder
- Maximum compressor pressure: 36 psi
- Compressor air flow: 6-8 lpm
- Nebulization particle size .05-10 microns
- Unit weight: 3 lbs. 9 oz.
- Dimensions: 7-1/2"L x 6"W x 4-1/2"H
- Latex-free

(NOTE: Replacement parts available)

HCPCS
A7003

Complete Nebulizer System

Compressor, nebulizer, angled mouthpiece, 7 ft. air tubing, five air filters, removable power cord, detailed English/Spanish instruction manual and FAQ pamphlet.

VH Complete™ Tabletop Compressor Nebulizer System

CONVENIENT ALL-IN-ONE STORAGE DESIGN
FAST AND EFFECTIVE MEDICATION DELIVERY - EASY, ONE-BUTTON OPERATION



POWER CORD STORAGE

- Piston-style compressor pump
- Treatments delivered in 8-10 minutes
- Handy self-contained design
- Accessory storage compartment
- Built-in power cord storage area
- Built-in nebulizer holder
- Built-in carrying handle
- Maximum compressor pressure: 36 psi
- Compressor air flow: 6-8 lpm
- Nebulization particle size .05-10 microns
- Unit weight: 4 lbs. 5 oz.
- Dimensions: 11-1/2"L x 6-3/4"W x 3-3/4"H
- Latex-free

HCPCS
A7003

Complete Nebulizer System

Compressor, nebulizer, angled mouthpiece, 7 ft. air tubing, five air filters, detailed English/Spanish instruction manual and FAQ pamphlet.

#11-503 - VH Complete Tabletop Compressor Nebulizer

VH Sonic Mist™ Ultrasonic Nebulizer System

RELIABLE ULTRASONIC TECHNOLOGY
QUIET, QUICK TREATMENTS - PORTABLE CONVENIENCE

- Reliable ultrasonic technology
- Most treatments delivered in less than 6 minutes
- Creates smaller, more uniform particle size than compressor-style nebulizers
- Consistent nebulization: Particle size 1-10 microns
- Virtually silent medicine administration

- Handheld, portable design weighs less than 1 lb.
- Automatic shut-off
- Operates with tap or distilled water
- Three power options: rechargeable battery pack, AC adapter and DC auto adapter

#11-520 - Ultrasonic Nebulizer System

Complete Nebulizer System

Nebulizer, rechargeable 12-volt NiMH battery back, 12-volt AC adapter, 12-volt DC auto adapter, child mask, adult mask, extension tube, nasal piece, two mouthpiece styles, five medication sups, one air filter and base, carrying tote, detailed English/Spanish instruction manual and FAQ pamphlet.



Electronic Lice Comb Chemical Free Solution

DETECTS & DESTROYS LICE ON CONTACT - CONVENIENT BRIGHT LED SPOTLIGHT

- Small electronic charge safely kills adult lice on contact
- Quiet operation, no buzz or electronic hum
- Removable metal comb with insulated comb tips
- Two operation modes 0 on, on with LED light
- Bright LED spotlight for use on dark hair or in low-light settings

- Louse detection red light LED alert
- Built-in cleaning brush for clearing tines
- Ready-to-use: 1 AAA battery pre-installed
- Unit size: 3" x 2.5" x 1", Weight 1.5 oz.

#15-001 - Electronic Lice Comb



Dexter Dragon™ & ClawDia Kitty™ **NEW!**

Pediatric Compressor Nebulizer System

- Piston-style compressor pump
- Treatments delivered in 8-10 minutes
- Deep-set carrying handle
- Built-in nebulizer holder
- Coordinating storage tote for each
- Maximum compressor pressure: 36 psi
- Compressor air flow: 6-8 lpm
- Nebulization particle size .5-10 microns
- Unit weight: less than 4 pounds
- Kitty unit dimensions: 7-1/2" L x 4-1/4" W x 4-1/2" H
- Dragon unit dimensions: 7-1/2" L x 4-1/4" W x 4-1/2" H
- Latex-free



Complete Nebulizer System: Compressor, nebulizer, angled mouthpiece, child mask, 7 ft. air tubing, five air filters, storage tote, detailed English/Spanish instruction manual and FAQ pamphlet.

#11-510 - Dexter Dragon Pediatric Compressor Nebulizer System

#11-512 - ClawDia Kitty Pediatric Compressor Nebulizer System

**FUN AND FRIENDLY DESIGN
FAST AND EFFECTIVE MEDICATION DELIVERY
ENCOURAGES ACTIVE INHALATION**

Nice-N-Cool™ 360° Gel Sleeve **NEW!**

Easy Roll On To Use Hot or Cold Therapy - No Straps
Compression Treatment for Pain and Swelling

- Revolutionary gel sleeve surrounds treatment area and delivers soothing comfort and compression
- Helps relieve pain and swelling
- Durable clinical grade polyurethane gel sleeve
- Pliable gel remains flexible and conforms to body contours
- Non-toxic, latex free
- Includes a cotton compression sleeve to prevent direct contact to skin



(#24-955)



(#24-956)



(#24-957)



(#24-958)

- Easy to use: freeze, refrigerate, hot water or microwave
- Small - 3" - 10"; Medium - 10" - 15"; Large Fits Limb Circumference 15" - 21"

#24-955 Finger, 1" ID X 4" L

#24-956 Small, 4" ID X 6" L (Hand-Wrist-Arm)

#24-957 Medium, 5" X 6" L (Ankle-Foot-Elbow)

#24-958 Large, 6" X 6" L (Feet-Calf-Knee)



2-in-1 Gel Wrap Therapy

- Compression therapy treatment for ankle or elbow
- Two sets of dual chamber gel packs fit securely inside wrap via hook and loop closure
- Uniform treatment with cold or hot
- Non-toxic latex free
- Cotton compression wrap included

#24-959 2-in-1 Gel Wrap Therapy



3-in-1 Gel Pack Cold Therapy

- Designed for shoulder, neck or hip treatment
- Multi-chambered gel sleeve attached to pliable plastic back - provides compression and keeps gel-packs in place
- Non-toxic, latex free
- Easy to use - freeze or refrigerate

#24-960 3-in-1 Gel Pack Cold Therapy



Nice-N-Cool™ Gel Mat



- Revolutionary gel core absorbs body heat
- Provides cooling relief for one hour,
- Decreases body temperature to promote good sleep
- Helps relieve night sweats and hot flashes
- Can safely come in contact with skin or placed under a sheet
- Designed to be used most anywhere, over and over again
- Blue self-cover with non-toxic gel center
- Hand wash only, air dry

Size 15.35" x 11.5"



KEEPS YOU COOL
NO REFRIGERATION REQUIRED
READY TO USE
#24-950 Nice-N-Cool™ Gel Mat



Tiny TENS Unit Pain Management Solution

NO PRESCRIPTION REQUIRED
NO PAPER WORK

- Ten levels of intensity
- Reusable snap-style electrode pads (2)
- Auto shut-off, wireless controller
- 1-button-cell battery included
- 20 minute therapy sessions
- 1 year limited warranty



#22-030 - Tiny TENS Unit
#22-030DP - Tiny TENS Unit - (3)
#22-039 - 3 Pack Electrodes



RH4300 Mini Oxygen Regulator

- Compact Design
- Lightweight, less than 10 oz
- Flow 0-15 liters/min.

#RH4300 Mini Oxygen Regulator

**HCPCS
E1353**

RH4200 Mini Oxygen Regulator

- Compact and lightweight, less than 10 oz.
- Flow: 0-8 L/min.

#RH4200 Mini Oxygen Regulator

**HCPCS
E1353**



Deluxe TENS Unit

**HCPCS
E0720**

- Provides relief from a variety of pain including: back pain, headaches, sports injury pain and general muscle pain
- Pulse width (60-250) and a pulse frequency (2-150) are adjustable
- Dual isolated channels (2 leads per channel)
- Device offers dual channels, fully adjustable parameters and three modes, burst (B), normal (N) and modulation (M)

Five year warranty

#T-2500

- Comes complete with timer, adjustable in 30 minute, 60 minute or constant time
- Two independent output terminals
- Equipped with a 360 degree wire connector
- Comes complete with carrying case, lead wires, 9-volt battery, manual and pack of 4 self adhesive electrodes

#T-2500 Deluxe TENS Unit

#TENS Accessories for T2500 and T6000
#T6010 - Electrode (1.75 inch, 45 mm round)
#T3600 - 360° Lead Wires

**HCPCS
E0730**

Digital TENS Unit with 5 Mode Options



#T-6000

- Simple to operate, portable device for pain treatment
- Five year warranty
- Pulse width (50-300) and pulse frequency (2-150) are adjustable

- Unit can set parameters accurately and easily operate with LCD display to monitor the patients' condition
- Includes a patient compliance timer that records individual session time and cumulative time
- Unit has five mode outputs - Burst (B), Normal (N), MRW, Strength Duration (SD) and Bi-Pulse.
- Comes complete with carrying case, lead wires, 9 -volt battery, manual and pack of 4 self-adhesive electrodes

#T-6000 Digital TENS Unit

A			
Aids to daily living	31-38	Foot stool	23
Alternating pump & pad	22	Forearm crutches	8
Arm Slings	40	G	
Auto Aids	38	Gait belt	25
Auto grip	38	Gel cushions	41, 42, 44
B		Gel Sleeves	64
Back sponges	28	Gloves	36
Back supports	40	Gowns	54
Bariatric products	20, 21	Grab bars	17
Bath brushes	28	Grip Alert	19
Bath mat and Shower mat	17	H	
Bath rail	16	Hair shampoo-er	31
Bath safety treads	17	Hair stand	36
Bath & shower seats	15, 21	Hand held shower	17
Bed boards	23	Handi-Exerciser	35
Bed & chair riser	25	Heating Pad	37
Bed pads	10, 25	Heel & elbows pads	25
Bed rails & Accessories	10, 22	Heel Saver	55
Bed trays	22	Hernia Support	52
Bed wedges	46	Hip/Knee replacement kits	29, 30
Bibs	32	Hot water bottles	39
Blanket support	23	Hygiene Products	50
Blood Pressure & Pulse Monitor	60-61	I	
Body brush	37	Ice bags	34
Body positioner	49	Incontinent products	52-53
C		Industrial back supports	40
Canes	6, 7, 20	Invalid rings	41
Cane accessories	6, 7, 8, 9	I.V. stands	11
Cane tip	7	K	
Call bells	25	Kiegel exerciser	52
Car Seat Belts	1, 20	Kitchen aids	33
Cards, Card holders	36	Knee pillows & wedges	47
Cast and bandage protectors	50	Knee walker	2
Cast shoes	56	Knee warmers	44
Cervical collars	40	Knee wedge	48
Cervical pillows	49	L	
Clothing Protectors	32	Lap trays	22
Coccyx cushions	43, 44	Latex foam cushion	44
Commodes	13, 18	Leg lifter	27
Commode cushions	14	Lice Comb	63
Commode pails	13	Long handle brush	28
Contour fitted sheets	51	Lotion applicator	31
Convuluted Pads/Cushions	22, 41, 43	Lumber back supports	39, 42-48
Crutches	8	M	
Curb Ramp	12	Magnifiers	35
Cushions	41-45	Mattress clamp	11
Cutlery	33	Mattress protectors	51, 52
D		Medication planner	36
Decubitus pads	25	Medi-timer	36
Diabetic Skin Care	58	N	
Diabetic Socks	58	Nail Clipper	37, 57
Digital Thermometers	62	Nebulizer Systems	63, 64
Door hinge	25	Neck Cushions	47
Draw sheet	51	O	
Dressing Aids	26, 27	Overbed tables	2
E		Overdoor traction sets	11
Elastic supports	39	Oxygen cart & Accessories	4, 11
Exercise pulley set	11	Oxygen Regulators	65
F		P	
Face Masks	59	Page magnifier	35
Foam Collars	40	Patient gowns	54
Foam ring cushions	41	Pedal exerciser	11
Foot Brush	57	Pedometer	35
Foot care products	55, 56, 57	Pens	31
Foot exerciser	22	Personal care products	31
		Pill cutter/crusher	36
		Pillows	48, 49
		Plastic ware	24
		Playing cards	36
		Post-op shoes	56
		Posture Supports	39
		Pouches	4, 5
		Power putty	34
		Prostate Cushions	45
		Pulse Oximeter	62
		Q	
		Quad canes	8, 20
		R	
		Raised toilet seats	14
		Ramps	12
		Reachers	26
		Rib belts	40
		Rollators	1, 20
		Rubber/Flannel sheeting	51
		Rubber rings	41
		S	
		Saf-er grip	18
		Sciatica Cushions	48
		Scissors	39, 57
		Seat belt	1
		Seat-lifter	22
		Sheets, fitted	51
		Shoe horns	27, 28
		Shoe laces	27
		Shopping cart	23
		Shower holder	18
		Shower massager	37
		Shower mats	17
		Sleep Apnea Products	59
		Smoker's apron	32
		Sock & stocking aid	27
		Stethoscopes	60
		Suction foot rest	18
		Suction tub bars	18, 19
		Swivel seat cushion	21, 38
		T	
		TENS Units	65
		Toilet aids	50
		Toilet safety rails	13
		Traction	11
		Transfer benches	15, 21
		Transfer boards	12
		Transport bags	23
		Transport chair	1
		Trapeze set	11
		Tub bars	18
		TV listener	37
		U	
		Underpads	51, 53
		Uplift seats	22
		W	
		Walker accessories	3, 4, 5, 19
		Walker basket	4
		Walker Glides	3
		Walkers	3, 20
		Waterproof sheeting	51
		Wheelchair accessories	5, 9
		Wheelchair cushions	42, 43, 44, 45
		Wheelchair ramps	12
		Wheelchair trays	9
		Whirlpool	16
		Wrist brace	40